



The GLE SUV

As from 01st July to 31st August 2022

Mercedes-Benz



Welcome

At Mercedes-Benz we appreciate the importance of detail. Over the following pages you'll find model prices and a breakdown of standard and optional equipment, as well as details of the attractive finance offers and benefits that are available to every Mercedes-Benz driver.

We have highlighted some of the best styling features both inside and out, some of the new technology features and some body styling options which all combine to give you a unique driving experience. To experience a full listing of what is available; please speak directly to your local Mercedes-Benz Dealer.

Of course, some things have to be experienced to be truly appreciated, such as the qualities that set a Mercedes-Benz apart, which is why we'd like to invite you for a test drive at your local Mercedes-Benz Dealership. Discover the location and the contact details of your local Mercedes-Benz Dealership at **www.mercedes-benz.ie**



Some of the model features, optional extras and colours shown may not be available, or may only be available in a different specification, or at a different price.

Price List

Petrol

Model Description	Wheel size	CO2	VRT Rate	Road Tax	CC	BHP	Price*
GLE 450 4MATIC	19"	191 +	41.00%	€1,250	2999	367	€132,240
GLE 450 4MATIC Standard Interior / AMG Line Exterior	20"	191 +	41.00%	€1,250	2999	367	€140,138
GLE 450 4MATIC AMG Line	20"	191 +	41.00%	€1,250	2999	367	€143,092

Diesel

Model Description	Wheel size	CO2	VRT Rate	Road Tax	CC	BHP	Price*
GLE 300 d 4MATIC	18"	156-170	30.00%	€280	1993	272	€98,965
GLE 300 d 4MATIC Standard Interior / AMG Line Exterior	20"	171-190	35.00%	€600	1993	272	€113,637
GLE 300 d 4MATIC AMG Line	20"	171-190	35.00%	€600	1993	272	€116,351
GLE 400 d 4MATIC	19"	171-190	35.00%	€600	2925	330	€121,670
GLE 400 d 4MATIC Standard Interior / AMG Line Exterior	20"	191 +	41.00%	€1,250	2925	330	€140,393
GLE 400 d 4MATIC AMG Line	20"	191 +	41.00%	€1,250	2925	330	€143,347

*Prices applicable to all models registered from 01st July to 31st August. Subject to availability. Terms & Conditions apply. Prices quoted do not include dealer and delivery related charges. Owing to supply shortages, options for vehicles may be temporarily restricted, resulting in modified vehicle and/or package pricing. Regularly updated information on this issue is available from Mercedes-Benz dealers.

Price List

Diesel Plug-In Hybrid

Model Description	Wheel size	CO2	VRT Rate	Road Tax	CC	BHP	Price*
GLE 350 de 4MATIC	19"	0-50	7.00%	€140	1950	**	€93,295
GLE 350 de 4MATIC Standard Interior / AMG Line Exterior	20"	0-50	7.00%	€140	1950	**	€99,061
GLE 350 de 4MATIC AMG Line	20"	0-50	7.00%	€140	1950	**	€101,028
** 1,950cc, 4-cylinder, 194hp - Electric Motor 136hp							

MERCEDES-AMG

Model Description	Wheel size	CO2	VRT Rate	Road Tax	CC	BHP	Price*
Mercedes-AMG GLE 53 AMG 4MATIC+ Premium	20"	191 +	41.00%	€2,400	2999	435	€169,555
Mercedes-AMG GLE 63 AMG 4MATIC+ Premium	20"	191 +	41.00%	€2,400	3982	571	€223,175
Mercedes-AMG GLE 63 S AMG 4MATIC+ Premium	21"	191 +	41.00%	€2,400	3982	612	€242,065

*Prices applicable to all models registered from 01st July to 31st August. Subject to availability. Terms & Conditions apply. Prices quoted do not include dealer and delivery related charges. Owing to supply shortages, options for vehicles may be temporarily restricted, resulting in modified vehicle and/or package pricing. Regularly updated information on this issue is available from Mercedes-Benz dealers.



Some of the model features, optional extras and colours shown may not be available, or may only be available in a different specification, or at a different price.



Some of the model features, optional extras and colours shown may not be available, or may only be available in a different specification, or at a different price.



Some of the model features, optional extras and colours shown may not be available, or may only be available in a different specification, or at a different price.



Some of the model features, optional extras and colours shown may not be available, or may only be available in a different specification, or at a different price.



GLE



Technology

Some of the model features, optional extras and colours shown may not be available, or may only be available in a different specification, or at a different price.

Mercedes-Benz User Experience (MBUX)

Transforming the in-car user experience, thanks to MBUX: Controlled via voice or touch input, the innovative infotainment system can over time even predict personal habits thanks to artificial intelligence.



Multi-gesture touchpad control



Using the touchpad you can control the display of the multimedia system

Voice control

- Activated by the keywords “Hey Mercedes”, the new intelligent voice control LINGUATRONIC¹ lets you control many of the infotainment functions, including destination input, phone calls or music selection
- MBUX is able to understand different accents and will adjust to you over time
- MBUX even understands indirect commands. Feeling chilly? Just say “I feel cold” and MBUX will adjust the temperature for you

Touch inputs

- Beside voice control you can operate MBUX via touchscreen, the touchpad on the centre console, as well as touch control buttons on the steering wheel
- The touchpad recognises your handwriting should you wish to enter addresses or phone numbers silently

Personalisation

- Turn the new GLE into your very own Mercedes-Benz by personalising driving modes, radio stations and much more
- Your personal settings can be saved in up to seven different profiles, making your driving experience the best one possible
- Thanks to artificial intelligence, MBUX is able to learn and adapt over time. It will be able to predict your personal habits, such as navigation for frequently-driven routes, or the radio station you like to listen to on your way home from work

Maintenance and service

- Wondering when the next service is due? Or how much further you can drive until you need to stop at a petrol station? Just ask your MBUX – it will tell you the answer

¹LINGUATRONIC off-board functions are currently only available for three years

Mercedes me connect

Stay connected any time, anywhere.

Mercedes *me*

Mercedes me is a range of innovative online services designed to enhance your Mercedes-Benz experience. Accessible via mobile, tablet or PC, Mercedes me lets you enjoy the highest standards of care and support, in a way that integrates seamlessly with your busy lifestyle.

Safety and Service – Mercedes me connect helps to keep you and your car safe

Check your car's oil level, tyre pressure and fuel from your phone so you'll be ready for every journey.

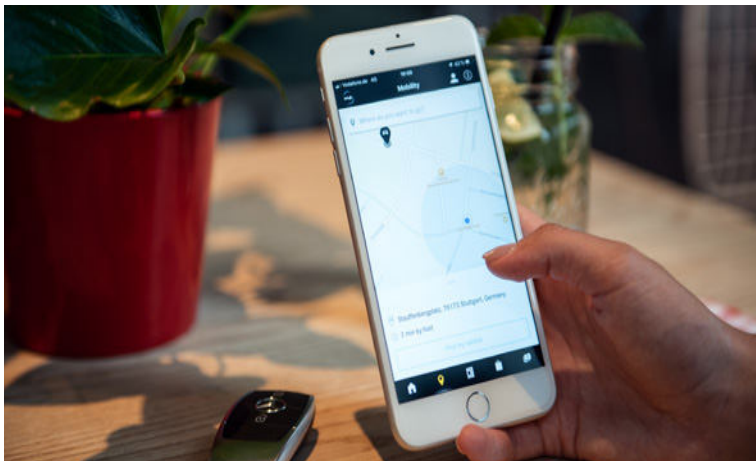

Live Traffic Information, Parked Vehicle Locator and much more with Mercedes me connect

Forgot where you've parked? Parked Vehicle Locator¹ will show you exactly where your car is as long as you're in a 1.5 km radius of where you parked. Real-time traffic data and dynamic route with shorter journey times.

Comfort – connect to your car anytime, anywhere

Forgot to lock your car? With Remote Car Lock² you will receive a notification on your smartphone to let you know. With one tap, you can lock and unlock your vehicle so you never have to worry.

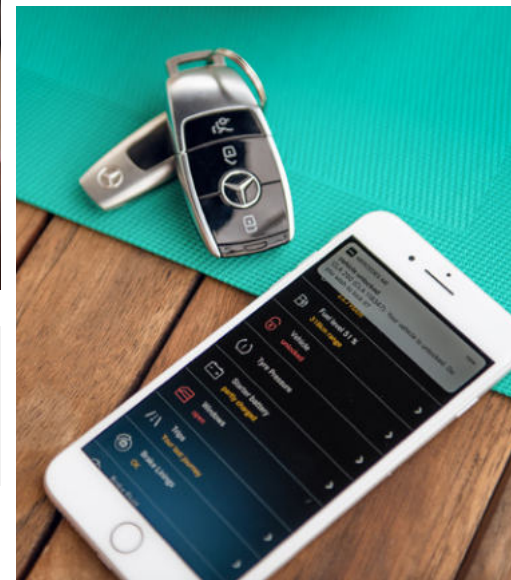

¹Available on all models with the Vehicle Monitoring package. This option may vary between standard and additional cost dependent on the model

²Part of the Vehicle Status package. This option may vary between standard and additional cost dependent on the model

Images shown are for illustration purposes only

Driving Assistance package

The Driving Assistance package contains a range of highly intelligent features to help you stay safe on the road.

Driving Assistance package (code 23P) – designed as a package, including items as listed.

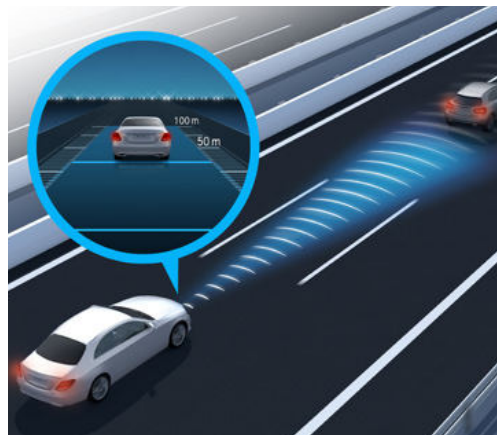

Active Blind Spot Assist can warn the driver of vehicles in the blind spot during a lane change and can help to avoid a collision by means of one-sided braking intervention

Active Braking Assist with cross-traffic function can help to avoid accidents with vehicles ahead, crossing traffic and also pedestrians, and/or mitigate their consequences

Active Distance Assist DISTRONIC helps maintain the desired distance from the vehicle in front

Active Emergency Stop Assist: immediate emergency braking if evasion is impossible

Active Lane Keeping Assist

Active Speed Limit Assist ensures detected speed limits are automatically adopted as the set speed for Active Distance Assist DISTRONIC

Active Steering Assist: targeted steering intervention to prevent unintentional drifting out of lane

Active Stop-and-Go Assist⁴

Evasive Steering Assist can support the driver in making evasive manoeuvres if, in a dangerous situation, he/she moves to avoid any pedestrian detected by the system

Pedestrian warning function near pedestrian crossings

PRE-SAFE[®] PLUS: when a rear-end collision threatens, it can initiate preventive measures, including warning following traffic and locking the brakes on standstill

Route-based speed adjustment: adaption of speed before curves, roundabouts and junctions

Traffic Sign Assist

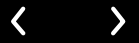

GLE

Plug-In Hybrid

Plug-in Hybrid Electric Vehicle (PHEV) The GLE 350 de.

Plug-in hybrid vehicles enjoy the same functionality of full Hybrid technology, with the added benefit that they can be charged from an external electricity source.

GLE 350 de 4MATIC

Diesel – 1,950 cc, 4-cylinder, 194 hp/143 kW

Electric motor – 136 hp/100kW



Not available with 7 seats

Standard equipment

Charging cable – Mode 3 cable (5 metres, straight), for wallbox and public charging stations + 3 pin domestic cable

Charging socket

Charging system – AC charging system rated at up to 7.4 kW (3 phase)

Pre-entry climate control

Radar-based recuperation

Remote and Charging Services Plus

Technical details

Equivalent All-Electric Range (EAER) ¹	94–96 km
AC charging time, 10–100% ²	
At a domestic socket ³	11 hrs 30 mins
At a wallbox (3.7 kW AC Single Phase)	6 hrs 45 mins
At a charging station (7.4 kW AC Three Phase)	3 hr 30 mins
	**Optional DC Charger Available
Range power consumption, combined ^{1,4}	29.3–27.7 kWh/100 km
Battery type (usable)	lithium-ion (31.0 kWh)
Capacity on-board charger	3.7 kW (AC Single Phase)/7.4 kW (AC Three Phase)

Some of the model features, optional extras and colours shown may not be available, or may only be available in a different specification, or at a different price. 1. The indicated values were determined according to the prescribed measurement method – Worldwide Harmonised Light Vehicle Test Procedure (WLTP). Figures shown may include options which are not available in Ireland. For Plug-in Hybrid Electric Vehicle (PHEV) figures determined with the battery fully charged, using a combination of both battery power and fuel. These models require mains electricity for charging. Additional options can decrease range. 2. Specified voltage and current values refer to network infrastructure and can be limited by the vehicle. Times are from 10–100% charge using a wallbox (single phase or three-phase) or standard socket (single-phase). 3. If you are planning to charge your Mercedes-Benz plug-in electric vehicle using a 3-pin domestic plug socket you must get a qualified electrician to inspect and sign off the socket to confirm it is safe and suitable to charge your vehicle. **Do not use an electric vehicle 3-pin charge cable with an extension cord.** 4. The certified electrical consumption is generally determined at maximum AC charging capacity using a Mode 3 cable. It is therefore recommended that vehicles with a HV battery preferably be charged at a wallbox or an AC charging station with a Mode 3 cable in order to achieve shorter charging times and improved charging.

< >
GLE Model lines overview



Standard Exterior



AMG Line Exterior



Standard Exterior equipment highlights



Engine, Transmission and Suspension

DYNAMIC SELECT with choice of driving modes: 'Eco', 'Comfort', 'Sport' and 'Individual'

Exterior

18" alloy wheels – 5-twin-spoke design, aerodynamically optimised (code R67) (19" R57 alloy wheel for 350 de)

Adaptive Highbeam Assist

Aluminium-look roof rails

Exhaust system with 2 chrome-plated tailpipe trim elements

LED High Performance headlamps

Mirror package: electrically folding outside mirrors, surround lighting with projection of brand logo

Mild hybrid with 48-volt on-board electrical system (300 d and 450 4MATIC only)

Summer tyres



Standard Interior equipment highlights



Interior

Ambient lighting, staged – 64 colours

Brushed aluminium trim with light longitudinal grain

DAB digital radio tuner

Four-way lumbar support

Mirror package – electrically folding mirrors and automatically-dimming driver's exterior mirror and rear-view mirror with image projection logo

Multifunction steering wheel in nappa leather

Roof liner in crystal grey fabric

Seats – heated front seats

Communications, Safety and Assistance Systems

Active Brake Assist

Blind Spot Assist

MBUX multimedia system with DAB digital radio tuner

Parking package – incl. Parking Assist and reversing camera

Touchpad

Traffic Sign Assist

Widescreen (12.3-inch x 2) cockpit display

Trim and Upholstery

Brushed aluminium trim with light longitudinal grain

Rough leather – black

AMG Line Exterior equipment highlights



In addition to/replacement of Standard Exterior
Exterior

(20-inch) AMG 5-twin-spoke light-alloy wheels painted in tremolite grey with a high-sheen finish

AMG front apron with chrome trim element and striking, sporty air outlets in the wheel arch linings

AMG side skirts painted in the vehicle colour

AMG rear apron with diffuser-look insert in black and trim strip in chrome

Diamond radiator grille with pins in chrome, integral Mercedes star and single louvre painted in matt iridium silver with chrome insert

Flared wheel arches at front and rear, painted in the vehicle colour



AMG Line Interior equipment highlights



In addition to/replacement of Standard Exterior
Interior

AMG sports pedals in brushed stainless steel with black rubber studs

AMG floor mats in black velour with "AMG" lettering

Brushed aluminium trim with light longitudinal grain

Multifunction steering wheel in nappa leather

- 3-spoke design, with flattened bottom section and perforated grip area
- Touch Control buttons and shift paddles plus steering wheel bezel in silver chrome
- Finished in black nappa leather with black topstitching

Trim and Upholstery

Brushed aluminium trim with light longitudinal grain



ARTICO man-made leather / DINAMICA microfibre black



7 Seat Package* equipment highlights



RZV



50R

In addition to/replacement of Standard Equipment

(20-inch) AMG 5-twin-spoke light-alloy wheels painted in tremolite grey with a high-shine finish (**RZV**) (included with AMG Line exterior)

(20-inch) 5-twin-spoke light-alloy wheels painted in Himalayas grey with a high-shine finish (**50R**) (included with standard exterior)

Electrically adjustable 2nd row seats

3rd row seating for two additional passengers

*Not available for 350 de PHEV or Mercedes-Benz AMG 53, 63, 63S models

Upholsteries

Standard Interior



Rough leather / leather black (201A)

Standard

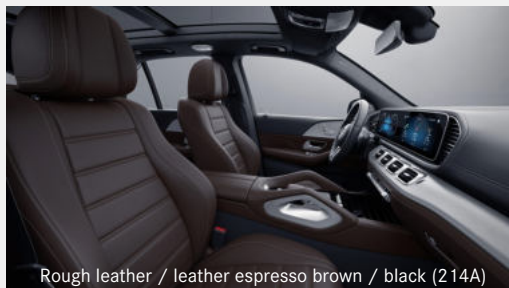

Rough leather / leather espresso brown / black (214A)

Option



Leather macchiato beige / black (215A)

Option



Nappa leather black (951A)

Option¹

AMG Line



ARTICO man-made leather/DINAMICA microfibre black (601A)

Standard

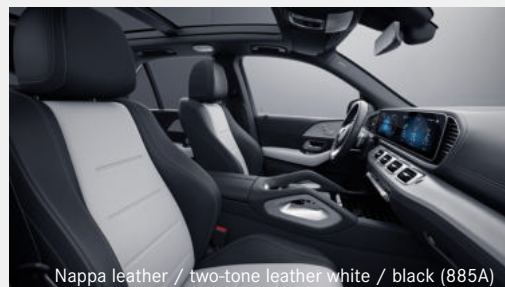

Nappa leather / two-tone leather white / black (885A)

Option

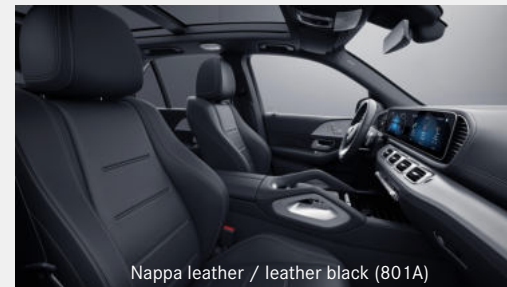

Nappa leather / leather black (801A)

Option

¹Only in conjunction with: Sidebags in rear + Heated rear seats + Memory package + Dashboard and door beltlines in ARTICO man-made / Nappa leather.

Trim options



Brushed aluminium trim with light longitudinal grain(H46)

Standard



High-gloss anthracite lime wood trim (H18)

Option



Brown open-pore walnut wood trim(H22)

Option



Anthracite open-pore oak wood trim elements(H31)

Option



MANUFAKTUR high-gloss brown lightlines lime wood(H34)

Option



MANUFAKTUR black flamed open-pore ash wood(H35)

Option



Metal-weave trim (H64)

Option

Wheel options

Standard Exterior



(18-inch) 5-spoke light-alloy wheels aerodynamically optimised, painted in black with a high-shine finish.
Standard 300 d (R67)



(18-inch) 10-spoke light-alloy wheels painted in vanadium silver.
Option (51R)



(19-inch) 5-spoke light-alloy wheels aerodynamically optimised, painted in black with a high-shine finish
Standard 350 de (R57)



(19-inch) 10-spoke light-alloy wheels painted in vanadium silver
Option 350 de (27R)



(19-inch) 5-spoke light-alloy wheels aerodynamically optimised, painted in black with high-shine finish
Standard 400 d (R39)



(19-inch) cross-spoke light-alloy wheels painted in himalayas grey with a high-shine finish
Option (15R)



(19-inch) 10-spoke light-alloy wheels painted in Himalayas grey with a high-shine finish
Option (R26)



(20-inch) 5-twin-spoke light-alloy wheels painted in Himalayas grey with a high-shine finish
Option (50R)



(20-inch) 5-spoke light-alloy wheels aerodynamically optimised, painted in black with a high-shine finish
Option (R61)

Wheel options

AMG Line Exterior



(20-inch) AMG 5-twin-spoke light-alloy wheels painted in tremolite grey with a high-shine finish
Standard (RZV)



(20-inch) AMG 5-twin-spoke light-alloy wheels painted in black with a high-shine finish
Option (RZW)



(21-inch) AMG multi-spoke light-alloy wheels painted in himalayas grey with a high-shine finish
Option (RWA)



(21-inch) AMG multi-spoke light-alloy wheels painted in black with a high-shine finish
Standard (RWB)



(22-inch) AMG 5-twin-spoke light-alloy wheels painted in tremolite grey with a high-shine finish
Option (RXS)



(22-inch) AMG 5-twin-spoke light-alloy wheels painted in black with a high-shine finish
Option (RXT)

Some wheels are only available as part of a package and/or with certain engine types. Subject to availability. Please use our Online Configurator or speak to your local Mercedes-Benz Dealership for more information.

Colour options

● Standard X Option



149 polar white non-metallic X



859 mojava silver metallic X



922 high-tech silver metallic X



992 selenite grey metallic X



799 MANUFAKTUR diamond white metallic X



197 black non-metallic ●



197 obsidian black metallic X



989 emerald green metallic X



996 MANUFAKTUR hyacinth red metallic X

Please note that, owing to limitations of on-screen representation, paint colours may differ from those shown

Premium Package From¹ €506

- **Parking Package with 360-degree camera:**
Park with peace of mind. The all-round visibility thanks to the 360 degree camera including a virtual birds-eye view is particularly impressive.

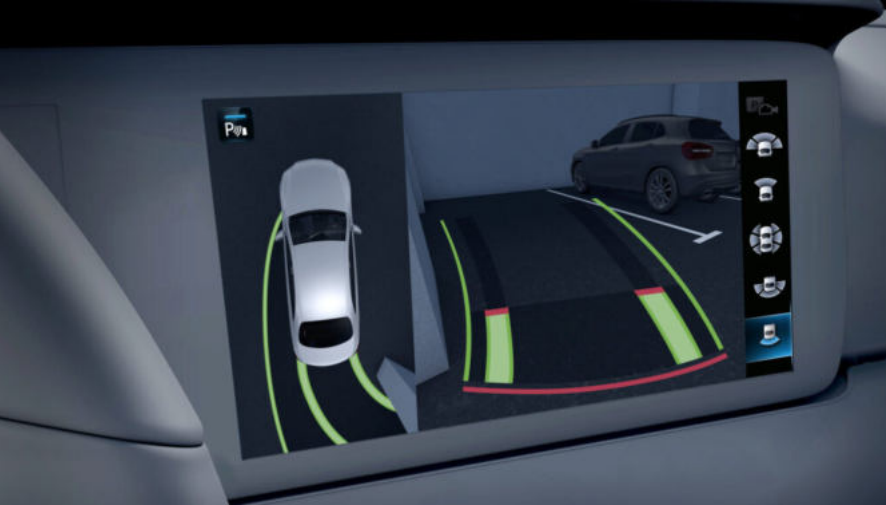

1. Price and availability subject to vehicle specification Owing to supply shortages, options for vehicles may be temporarily restricted, resulting in modified vehicle and/or package pricing . Regularly updated information on this issue is available from Mercedes-Benz dealerships.

Premium Plus Package From¹ €6,271

In addition to/replacement of Premium Package components

- **Burmester® surround sound system**

The basis for the impressive sound is provided by the 9-channel DSP amplifier, whose output power is perfectly matched to the speaker system. 13 high-performance speakers and a system output of 590 watts create an imposing sound field. Sophisticated vehicle noise compensation (VNC) adjusts music and sound dynamically to your driving conditions. With the fader and balance function, you can distribute the sound more to the front, rear or equally to all seats – or focus the listening experience in a seat row of your choice with the Sound Focus function. The Equaliser function can be set to suit your tastes, allowing individual adjustment of high, medium and low frequencies

- **Panoramic sliding sunroof**

Whether open or closed, with the panoramic sliding sunroof, you experience a wonderful feeling of freedom and enjoy a pleasantly bright ambience in the interior. When viewed from the outside, the large sliding sunroof likewise makes a unique visual impression, as it lends lightness and exclusivity to the exterior.

- **KEYLESS-GO Comfort package**

The KEYLESS-GO access and drive authorisation functions enable all the doors to be unlocked and locked merely by touching the door handle. HANDS-FREE ACCESS is another convenience function included in the package: this enables the boot lid to be opened and closed fully automatically – with a simple kicking motion below the sensor in the rear bumper. This is particularly helpful when you have both hands full with shopping bags.



1. Price and availability subject to vehicle specification. Owing to supply shortages, options for vehicles may be temporarily restricted, resulting in modified vehicle and/or package pricing. Regularly updated information on this issue is available from Mercedes-Benz dealerships.

AMG Line Night Package From¹ €877

More character – expressive style. In combination with the AMG Line, the Night package adds striking highlights in the form of exclusive black design features. These accentuate the sporty character and athletic design idiom of your vehicle. Ideal for individualists who appreciate an expressive design..

Components:

- (20-inch) AMG 5-twin-spoke light-alloy wheels painted in high-gloss black with high-sheen finish (RZW)
- Air inlets in radiator grille and front bumper in high-gloss black
- AMG front apron in A-wing design with trim strip in high-gloss black
- AMG rear apron with diffuser-look insert in black and trim strip in high-gloss black
- Diamond grille with pins in chrome and louvre in high-gloss black
- Exterior mirror housings painted in high-gloss black
- Heat-insulating dark-tinted glass from the B-pillar (840)
- Roof rails in matt black
- Windowline trim strip and beltline trim strip in black



1. Price and availability subject to vehicle specification. Owing to supply shortages, options for vehicles may be temporarily restricted, resulting in modified vehicle and/or package pricing. Regularly updated information on this issue is available from Mercedes-Benz dealerships.

Trailer coupling with ESP® trailer stabilisation

Expand your transportation options: with this practical equipment you can hitch up trailers or caravans and also mount bicycle racks. The fully electric trailer hitch moves into position at the press of a button or swings completely back after use – without you having to get your hands dirty.

- Trailer hitch which folds in and out fully electrically
- Control button with LED light in the tailgate, load compartment or in the driver's door (dependent on model)
- ESP® trailer stabilisation

From¹ €2,103



1. Price and availability subject to vehicle specification. Owing to supply shortages, options for vehicles may be temporarily restricted, resulting in modified vehicle and/or package pricing. Regularly updated information on this issue is available from Mercedes-Benz dealerships.

Technical data

● Standard – Not available

Model	GLE 300 d 4MATIC	GLE 350 de 4MATIC	GLE 400 d 4MATIC	GLE 450 4MATIC	Mercedes-AMG GLE 53 4MATIC+	Mercedes-AMG GLE 63 S 4MATIC+
Engine						
Fuel delivery	Diesel	Diesel	Diesel	Petrol	Petrol	Petrol
Total displacement cc	1,993	1,950	2,925	2,999	2,999	3,982
Arrangement/cylinders/valves	in-line/4/16	in-line/4/16	in-line/6/24	in-line/6/24	in-line/6/24	V/8/32
Power ¹ hp (kW) at rpm						
Combustion engine	272 (200)/4,200	194 (143)/3,800	330 (243)/3,600–4,200	367 (270)/5,500–6,100	435 (320)/5,500–6,100	612 (450)/5,750–6,500
Electric motor [Mild hybrid drive]	[20 (15)]	136 (100)	–	[22 (16)]	[22 (16)]	[22 (16)]
System output	–	320 (235)	–	–	–	–
Torque ¹ Nm at rpm						
Combustion engine	550/1,800–2200	400/1,600–2,800	700/1,200–3,200	500/1,600–4,500	520/1,800–5,800	850/2,500–5,000
Electric motor [Mild hybrid drive]	–	440/0–2,000	–	–	–	–
System output	–	700/3,500–4,000	–	–	–	–
Compression ratio	15.5:1	15.5:1	15.5:1	10.5:1	10.5:1	8.6:1
Equivalent All-Electric Range (EAER) ² km	–	94 - 96	–	–	–	–
Battery type (usable) kWh	–	Lithium-ion/31.0	–	–	–	–
Power consumption, combined ² kWh/100 km	–	29.3–27.7	–	–	–	–
AC charging time, 10–100% ³						
At a domestic socket ⁴	–	11 hrs 30 mins	–	–	–	–
At a wallbox (3.7 kW AC Single Phase)	–	6 hrs 45 mins	–	–	–	–
At a charging station (7.4 kW AC Three Phase)	–	3 hrs 30 mins	–	–	–	–
DC charging time, 10–80% (60 kW)	–	20 mins	–	–	–	–
Capacity on-board charger	–	3.7 kW (AC Single Phase)/ 7.4 kW (AC Three Phase)/ 60 kW (DC) (Optional)	–	–	–	–
Emissions standard	EURO 6D-ISC-FCM	EURO 6D-ISC-FCM	EURO 6D-ISC-FCM	EURO 6D-ISC-FCM	EURO 6D-ISC-FCM	EURO 6D-ISC-FCM

¹Figures according to Directive 80/1269/EEC in the currently applicable version. ²The indicated values were determined according to the prescribed measurement method - Worldwide Harmonised Light Vehicle Test Procedure (WLTP). Figures shown may include options which are not available in Ireland. For Plug-in Hybrid Electric Vehicle (PHEV) figures determined with the battery fully charged, using a combination of both battery power and fuel. These models require mains electricity for charging ³Specified voltage and current values refer to network infrastructure and can be limited by the vehicle ⁴If you are planning to charge your Mercedes-Benz plug-in electric vehicle using a 3-pin domestic plug socket you must get a qualified electrician to inspect and sign off the socket to confirm it is safe and suitable to charge your vehicle. Do not use an electric vehicle 3-pin charge cable with an extension cord

Technical data

Model		GLE 300 d 4MATIC	GLE 350 de 4MATIC	GLE 400 d 4MATIC	GLE 450 4MATIC	Mercedes-AMG GLE 53 4MATIC+	Mercedes-AMG GLE 63 S 4MATIC+
Transmission							
9G-TRONIC PLUS 9-speed automatic		●	●	●	●	–	–
AMG SPEEDSHIFT TCT 9G automatic		–	–	–	–	●	●
Performance							
Acceleration 0–62 mph	sec	6.8	6.9	5.7	5.7	5.3	3.8
Top speed (electric mode)	kph	230	210 (140)	245	250	250 ⁵	280 ⁵
Weights and capacities							
Kerb weight ⁶	kg	2,280	2,655	2,280	2,230	2,305	2,420
Perm. Gross Vehicle Weight	kg	3,000	3,260	3,070	3,000	3,050	3,120
Boot capacity – seats up/seats down	l	630/2,055	490/1,915	630/2,055	630/2,055	630/2,055	630/2,055
Towing capacity – unbraked/braked with Towing package	kg	750/2,700 3,500	750/2,700 3,500	750/2,700 3,500	750/2,700 3,500	750/3,500 –	750/3,500 –
Fuel tank capacity/of which reserve	l	85/9	65/9	85/9	85/9	85/9	85/12.0
Turning circle	m	12.02	12.02	12.02	12.02	12.40	12.40
Fuel consumption^{7,8,9}							
Combined (consumption dependent on chosen optional equipment)	l/100 km	7.2–6.3	0.9–0.8	8.4–7.9	10.1–9.8	10.9–10.8	12.4

⁵Electronically limited ⁶Figures according to Directive 92/21/EC (kerb weight with fuel tank 90% full, driver, 68 kg, and luggage, 7 kg) for standard-specification vehicles. Optional extras and accessories will generally increase this figure and reduce the payload capacity accordingly ⁷All figures are based on a standard specification with the smallest tyre size ⁸The choice of wheels and transmission may affect CO₂ emissions and corresponding VRT rate. ⁹The indicated values were determined according to the prescribed measurement method – Worldwide Harmonised Light Vehicle Test Procedure (WLTP). Figures shown may include options which are not available in Ireland. Figures shown are for comparability purposes; only compare with other cars tested to the same technical procedures. Figures may not reflect real life driving results, which will depend upon a number of factors including factory-fitted options, accessories fitted (post registration), variations in weather, driving styles and vehicle load.

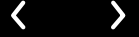

AMG Line

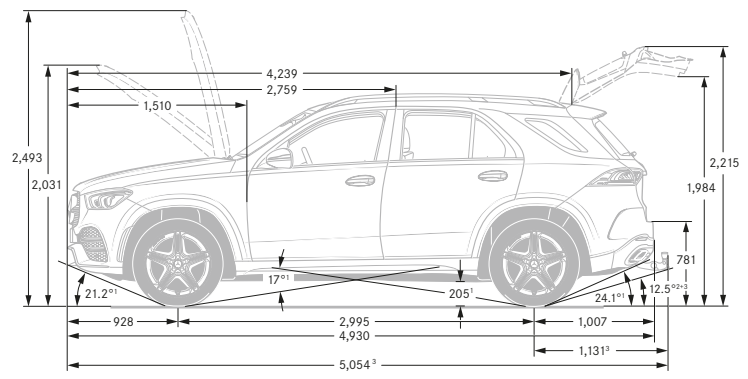
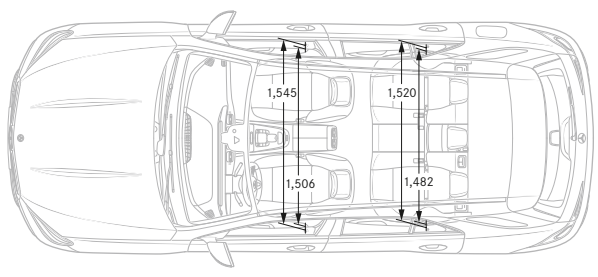
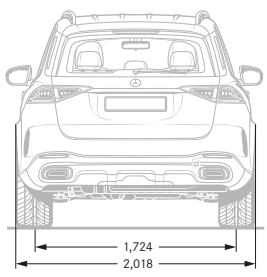
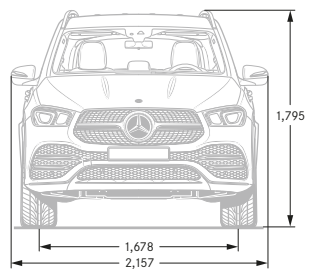

Mercedes-AMG GLE 53 4MATIC+

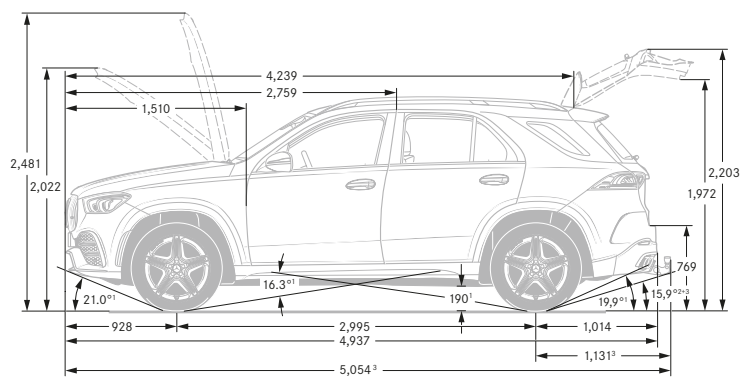
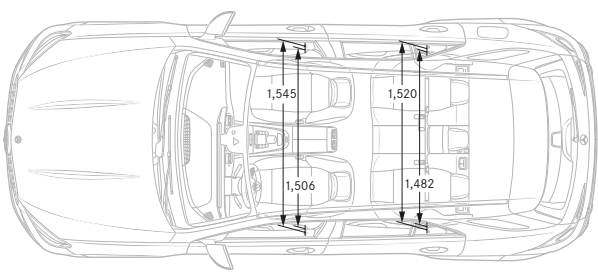
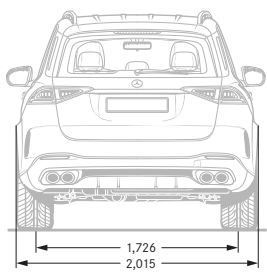
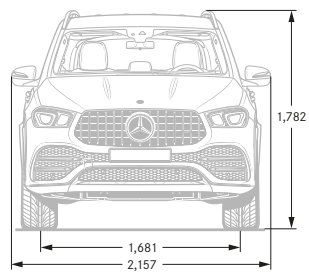

All measurements in millimetres. The dimensions shown are mean values and apply to standard-specification, unladen vehicles

Mercedes-AMG GLE 63 4MATIC+

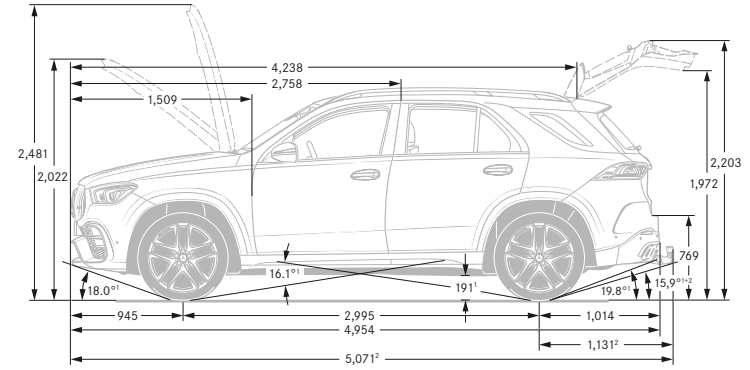
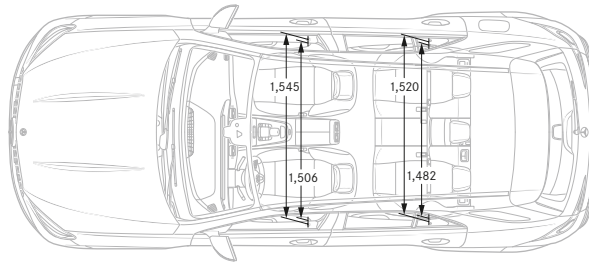
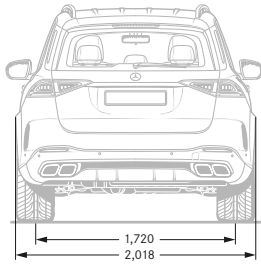
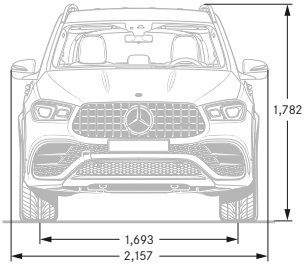



S:VV1671



Mercedes me

Welcome to your Mercedes-Benz world.

Imagine if ...you could connect with your Mercedes-Benz? With Mercedes me connect, you can! Mercedes me connect offers you new connectivity services that make driving more comfortable and incorporates your car into your personal lifestyle.

Standard Services

- Maintenance Management
- Telediagnosics
- Breakdown Management
- Accident Recovery
- Mercedes-Benz Emergency Call System

Remote Online Services¹

- Remote Retrieval of Vehicle Status (fuel level, tyre pressure etc.)
- Parked Vehicle Locator
- Vehicle Tracker
- Geofencing
- Door lock / unlock function

¹ Can be used with Remote Online special feature.





Getting connected is easy. Just set up your Mercedes me account and get in touch with your Mercedes-Benz dealer to connect your vehicle to your profile to access your Mercedes me connect services.

Contact your dealer to get connected, or go to www.mercedes.me for more details.

Follow us on the following social media channels:

 facebook.com/MercedesBenzIreland

 instagram.com/mercedesbenz_ireland

 [linkedin.com/company/motor distributors ltd](https://linkedin.com/company/motor-distributors-ltd)

 twitter.com/MB_IRELAND

 youtube.com/mercedesbenzireland

 pinterest.com/mercedesbenzire

Motor Distributors Ltd.
Naas Road
Dublin 12
Ireland
www.mercedes-benz.ie

Information correct at time of going to print. Prices and specifications are subject to change without prior notice. Prices quoted do not include dealer and delivery related charges. Images are for illustrative purposes only, actual product may vary. For more specific information in relation to the range of models, features, optional extras, colours and services available please speak to your local authorised Mercedes-Benz dealer.