

BYD SEAL

Product Guide - April 2024



BYD

Redefining the electric sports sedan

The BYD SEAL is revolutionising the European D-segment. The all-electric four-door sedan is spacious, versatile and luxurious, but undeniably sporty, dynamic and powerful as well. Beyond that, it's one of our most advanced vehicles to date, featuring breakthrough technology with which the BYD SEAL clearly distinguishes itself from its competitors.

The BYD SEAL is the second vehicle in BYD's Ocean series, designed according to the 'Ocean Aesthetics' design language. It combines a sleek and athletic appearance with a high level of comfort and versatility for five occupants, while it offers a comprehensive range of equipment,

and dimensions that perfectly match the needs of European car buyers. In addition, the BYD SEAL raises the bar with its cutting-edge technology and groundbreaking architecture, offering unprecedented levels of safety, cabin comfort and quietness, driving dynamics, performance and efficiency.

Contents

4	Exterior	26	Specifications
10	Interior	30	Technical data
14	e-Platform 3.0	32	Dimensions
20	Intelligence	33	Colours
24	Performance		

Blade Battery

Based on BYD's state-of-the-art e-Platform 3.0, the BYD SEAL uses the innovative 8-in-1 electric powertrain, as well as an in-house developed, cobalt-free Blade Battery which is revolutionary in several respects. Furthermore, the BYD SEAL is the first to implement BYD's highly advanced Cell-to-Body technology, which means the battery is incorporated in the entire vehicle structure, resulting in countless benefits in terms of safety, handling and space utilisation.

Spacious & luxurious

Packed with technology and high-quality materials and finishes, the BYD SEAL is also a full-options equipped, luxurious and versatile four-door sedan that comfortably seats five people. Combined with refined seats with soft and firm seat padding, eye-catching details and stitching, smart connectivity and leading infotainment, as well as an extensive range of advanced driver assistance systems, the BYD SEAL has all the qualities to become the favourite in the highly competitive electric D-segment.

26 min.

DC charging time 30-80%

up to 570 km

Range (WLTP combined)

3.8 s

0-100 km/h (AWD)



EXTERIOR

True masterpiece



The BYD SEAL is designed by the team led by Wolfgang Egger, BYD's Global Styling Design Director. It's a true masterpiece of ocean-inspired design and a proud recipient of the coveted iF Design Award, confirming its superior design and innovation.

As the second European model in the Ocean series to adopt BYD's Ocean Aesthetics design language, the BYD SEAL stands out from the crowd with its bold and flowing lines, alluring proportions and impressive aerodynamics.

Stunning "X" face

The front view of the BYD SEAL is characterised by a dynamic "X" architecture, which gives the vehicle a strong forward

thrust. The upper converging and lower diverging X features create a visually striking impact and an immediate sense of electrification. The extension of the front fascia design creates an athletic stance comparable to sports cars. Meanwhile, its sculpted and captivating curves, complemented by the double-U floating headlights and glistening "ripple" daytime running lights, provide the sense of the momentum of waves.



BYD SEAL.

Smooth and natural flow

The side profile has a smooth and natural flow, creating a distinctive coupe-like silhouette. The overall side view is characterised by vivid and expressive body lines such as the pronounced double waistlines, as well as the low-slung front hood, slanted A-pillar, rounded roof, downward-sloping fastback, and slightly upturned ducktail design. The water-cut line extending from the edge of the front hood creates a forward diving stance and slightly lifts after the C-pillar. This also enhances the overall flow of the body and balancing the proportion between the windows and the body. The shoulder line seamlessly connects with

the edge of the front hood, naturally blending into the rear doors.

Waterdrop taillights

The rear end of the BYD SEAL features a plump contour and dynamic lines, with the rear bumper incorporating a design that is not simply uniform. The decorative elements on both sides employ a dense horizontal grille, exhibiting exquisite details and an electrifying sense. The large central black air diffuser structure presents a racing-inspired sporty character, while also delineating the shape of a seal's tail fin through colour contrast, ingeniously echoing the theme of SEAL.



The design of the through-type LED tail-lights takes inspiration from water droplets, resulting in highly recognisable features. An ultra-narrow linear light strip seamlessly connects a matrix of water-drop-shaped lights, accompanied by slim and textured high-gloss chrome trim, creating an astonishing visual effect of a seamless line from the sea to the sky. The parameterised distribution of point light sources gradually decreases in size, generating a sense of depth and technology.

Carefully defined proportions

With an overall length of 4,800 mm and a wheelbase of 2,920 mm, the BYD SEAL's designers achieved a perfect axle ratio of 0.61. The diameter of the wheel arches and the body height at 1,460 mm create a perfect 1:2 ratio, carefully defining the "golden proportion relationship", resulting in an undeniably dynamic and elegant overall attitude. The vehicle's attractiveness is also defined by its standard-fit 19-inch Seiko Blade Wheels. They have a large sealing area to meet

The BYD SEAL is a true masterpiece of ocean-inspired design, with impressive aerodynamics, perfect proportions and an athletic stance. The fact that the BYD SEAL is highly appreciated for its design has been proven by winning the coveted iF Design Award.

the aerodynamic requirements. The colour shades match and the decorative parts come with frosted stripes for a sporty look.

Impressive aerodynamics

Furthermore, after many hours of wind tunnel testing, the BYD SEAL demonstrates power and athleticism with an exceptionally low drag coefficient of 0.219 Cd. Air resistance has a major influence on the vehicle's efficiency, as it increases quadratically with speed. In order to

achieve low energy consumption, drag must be minimised at high speeds as well. With its low-to-the-ground body style, smooth front design and sloping roofline, the BYD SEAL slices like a razor blade through the wind. To this end, the hidden door handle design also contributes to the low air resistance. The door handles retract and are flush with the doors when the vehicle is in motion and help to allow airflow to pass at high speed, reducing drag and the overall energy consumption of the vehicle.



Retractable door handles



19" Seiko Blade Wheel

Ocean Aesthetics design

"X" face design

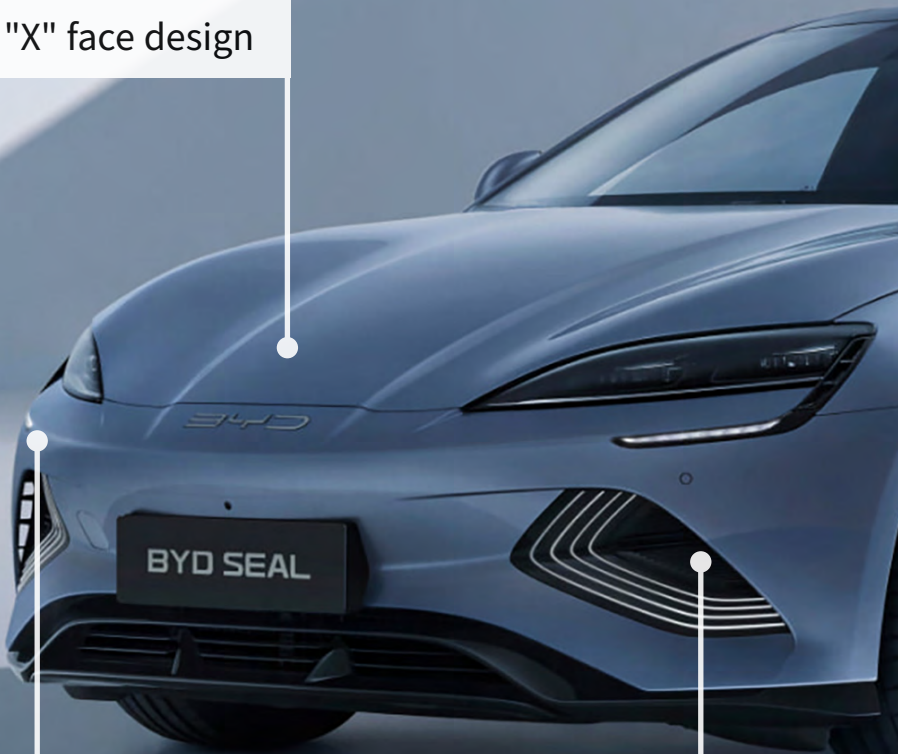
A blue BYD SEAL car is shown from a front-three-quarter view. Three white callout boxes with thin white lines pointing to specific features are overlaid on the image. The first callout points to the hood, the second to the left headlight, and the third to the right daytime running light.

Double-U floating
LED headlights

Glistening “ripple” daytime
running lights, themed on
ocean waves

The BYD SEAL is a highly attractive, distinctive and dynamic D-segment sedan, designed according to BYD's Ocean Aesthetics design language. It combines a sleek and athletic stance with exceptional aerodynamics, and dimensions that perfectly match the needs of European car buyers.

A side profile view of a light blue BYD SEAL sedan. The car is shown from the rear three-quarter view, highlighting its sleek, aerodynamic design. The roofline slopes down from the front and then slightly up at the rear, creating a ducktail shape. The car features multi-spoke alloy wheels and a charging port on the front fender.

Coupe-like silhouette with sloping roofline and slightly upturned ducktail shape

Dynamic side profile with double waist lines

INTERIOR

Versatile and luxurious



Packed with technology and high-quality materials and finishes, the BYD SEAL's comfortable and spacious cabin is a pleasant place to be. With great attention to detail and luxury, as well as practicality for five occupants, the BYD SEAL is one of the most versatile vehicles in its class.

Like the exterior, the interior design follows the Ocean Aesthetics design language and evolves into a signature “Surging Wave” style dashboard. With smooth and natural lines as the main theme, the dashboard differentiates functional areas through variations in materials and colour tones. The vents blend seamlessly with the sculptural lines and the rest of the dashboard design, striking a balance between functionality and aesthetics.

Crystal shifter

In addition to BYD's unique 15.6-inch rotatable touchscreen and the 10.25-inch full instrument LCD panel, craftsmanship and attention to detail are reflected in the crystal gear shifter. This exquisitely designed part serves as the visual centrepiece in the sub-dashboard console. Commonly used functions such as the start button, power mode selection, air conditioning, and audio can be controlled by intuitively



Premium interior with diamond stitching. Available in white (picture) or black.

placed mechanical buttons around the crystal shifter.

Comfortable and high-end cabin

The premium interior with the best finish in its class is further enhanced by the high-quality vegan leather upholstery with diamond stitching. The front seats have a sporty appearance with soft and firm seat padding, and excellent wrapping and support. The rear seats provide a comfortable seating position for three adult occupants, with legroom similar to that of an executive saloon and plenty of headroom, despite the car's low-slung styling. The seat back, cushion padding, as well as the angles of the rear seat back and cushion,

have been fully optimised, easing any fatigue on long journeys. On-board practicality and versatility are further reflected in more than twenty flexible storage spaces for small items in the interior.

Oversized sunroof

To make life even more enjoyable and comfortable, the BYD SEAL is equipped with an oversized panoramic sunroof as standard. Also, the front doors are fitted with double layered laminated glass for excellent sound and heat insulation, while the rear doors feature privacy glass with a solar transmittance of $\leq 25\%$, providing enhanced shade and privacy for rear occupants.



Panoramic sunroof: plenty of light in the interior thanks to an oversized surface with 1.3 m² light transmission.

Rotatable 15.6-inch touchscreen: choose whether you want the screen in landscape or portrait format.

Integrated sport seats: electrically adjustable and heated, with soft and firm seat padding, excellent support, high-quality upholstery and diamond quilting.



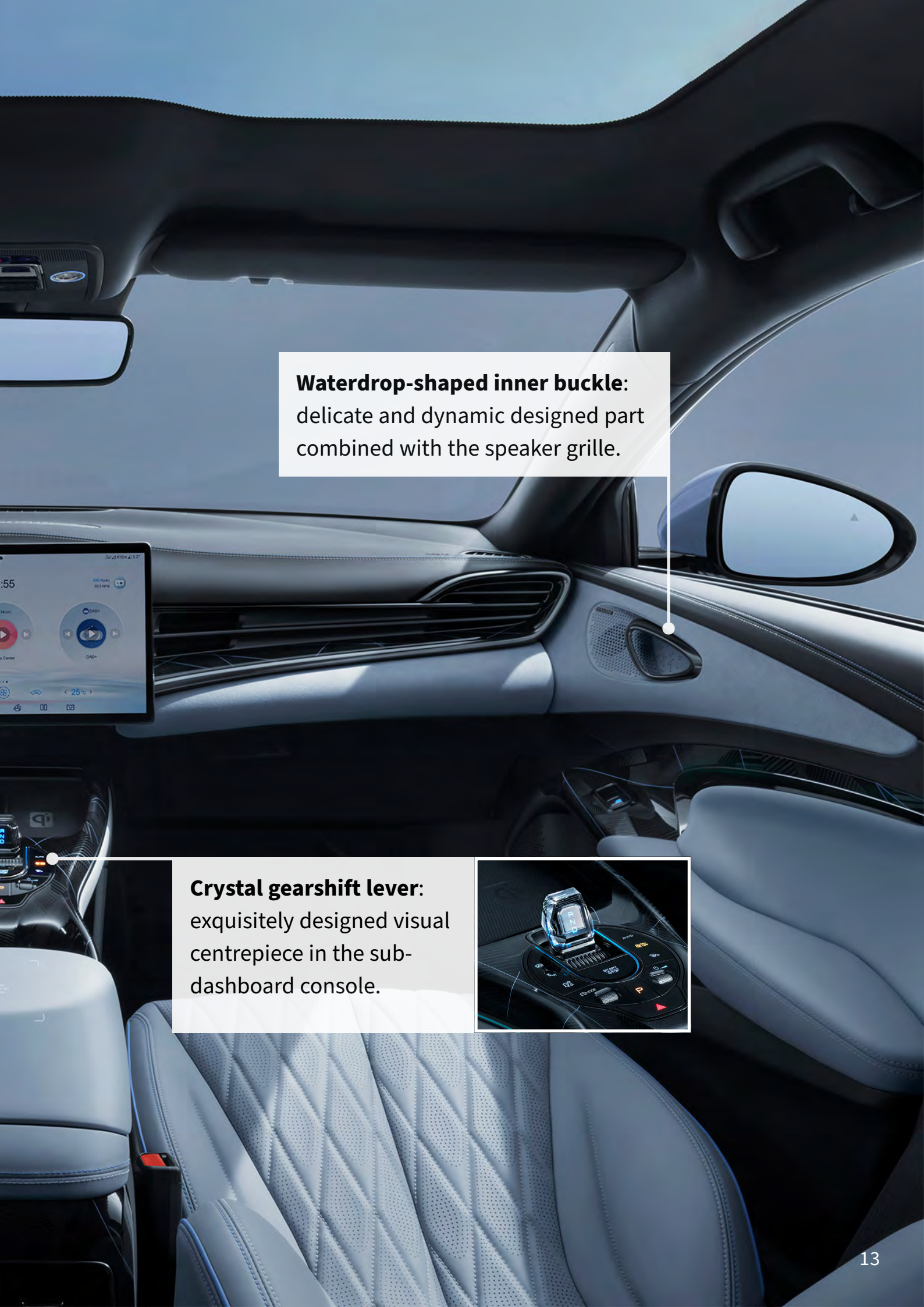

Waterdrop-shaped inner buckle:
delicate and dynamic designed part
combined with the speaker grille.



Crystal gearshift lever:
exquisitely designed visual
centrepiece in the sub-
dashboard console.

E-PLATFORM 3.0

Safe, efficient and intelligent

Designed exclusively for pure electric vehicles, with the Blade Battery, 8-in-1 electric powertrain and heat pump as key features, BYD's state-of-the-art e-Platform 3.0 offers outstanding advantages in terms of safety, intelligence, handling, aesthetics and space utilisation.

Cell-to-Body

However, the BYD SEAL is the first to implement BYD's highly advanced Cell-to-Body (CTB) technology, which means the battery is incorporated into the vehicle architecture as a structural component. In addition, the battery pack uses a high-strength aluminium honeycomb structure, contributing to the SEAL's exceptional torsional stiffness of 40,500 Nm/degree, further improving vehicle safety, body rigidity and driving dynamics.

More space

The e-Platform 3.0 and CTB technology also improve space utilisation. Due to the reduced battery pack volume, the BYD SEAL has a 10 mm lower body height with the same clear height inside the vehicle compared with the conventional structure, resulting in a more low-slung shape, improved aerodynamic performance and visual impact, as well as more cabin space.

e-Platform 3.0: 50:50 golden axle load ratio low center of gravity, small moment of inertia.

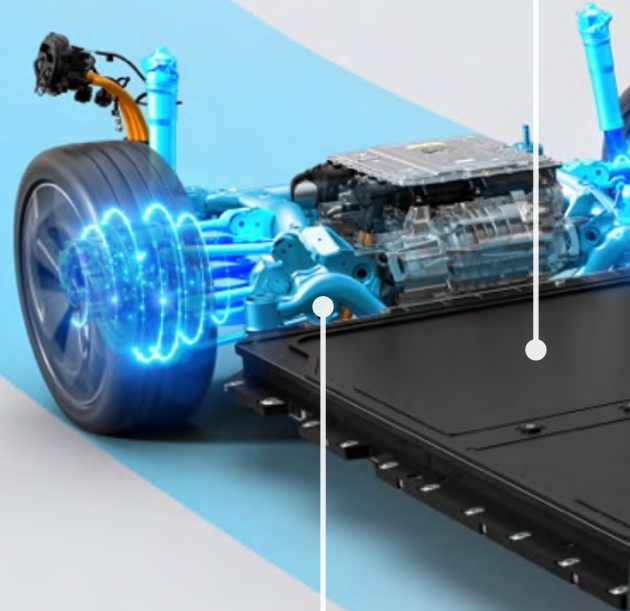

New suspension design: front double wishbone and rear five-link suspension endow the vehicle with sporty characteristics

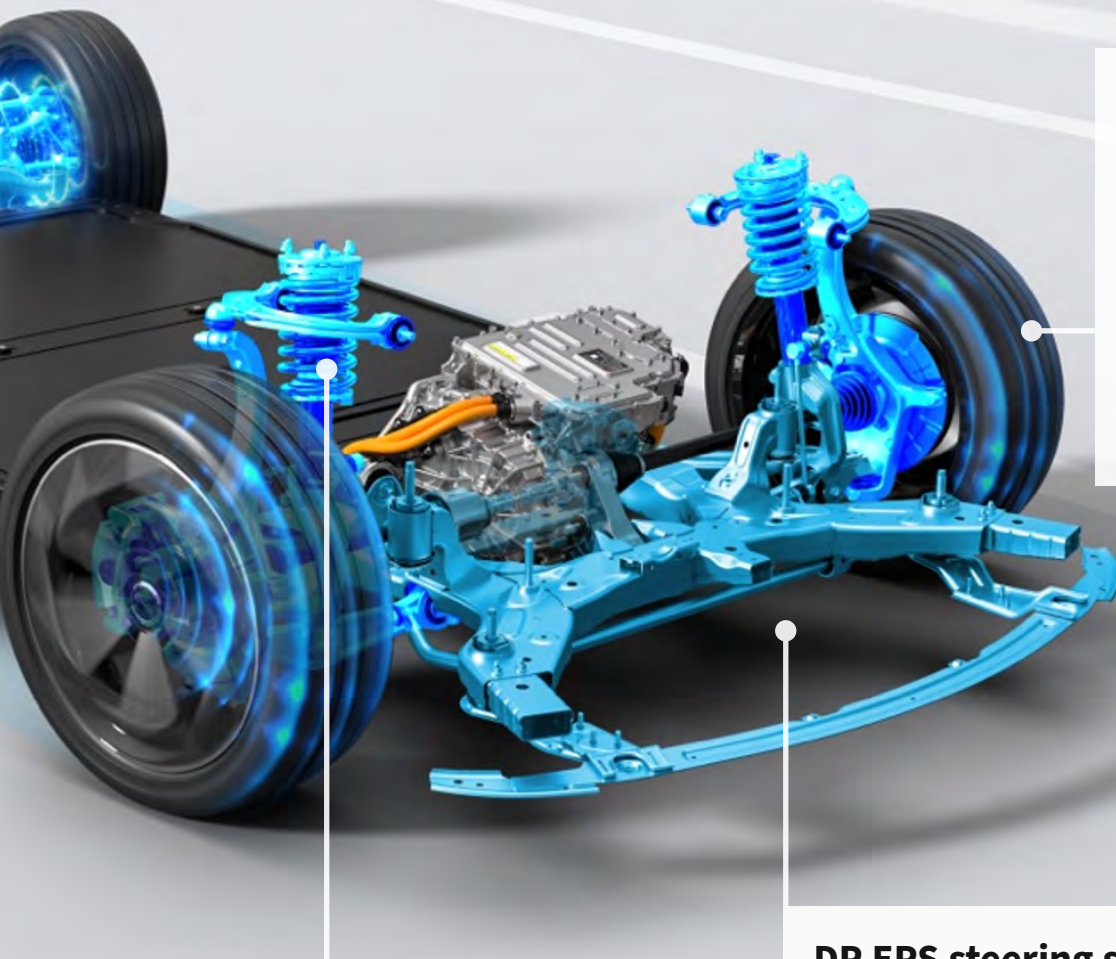

Continental Sport Contact 7 tires (AWD version): global debut, tailored for dynamic driving performance.

SDC3 Shock Absorber Valve System: ensures body control in various frequency ranges.

DP EPS steering system: BYD's first DP (Dual Pinion) steering system with small turning radius and high sensitivity.

Blade Battery

The BYD SEAL is powered by a Blade Battery, which is revolutionary in several respects. BYD has been pioneering battery technology for over two decades. 27 years on, with over three million battery powered cars produced for customers, BYD is firmly established as a market leader in this field. Its revolutionary Blade Battery is born out of BYD's relentless research and development, and considered as a major advancement for the EV industry.

Optimised strength

The Blade Battery was developed in-house by BYD with the primary goal of optimising safety, durability, longevity, performance and space utilisation. The battery pack consists of 172 thin elongated cells that actually look like blades. They are arranged neatly and evenly, with good temperature consistency and no heat accumulation. Arranged in an array in one pack, each cell serves as a structural beam to help withstand the force. The aluminium honeycomb-like structure, with high-strength panels on upper and lower side of the pack, greatly enhances the rigidity in vertical direction.

Lithium iron phosphate

The Blade Battery uses lithium iron phosphate (LFP) as a cathode material, which offers a higher level of safety and durability compared with conventional lithium-ion batteries. In addition, BYD's Blade Battery is 100% free of cobalt, a material that raises ethical and environmental concerns in the mining industry. LFP batteries are more resistant to extreme temperatures, without the risk of igniting or exploding. They have better thermal stability and are less sensitive to temperature fluctuations, while they can withstand more charge and discharge cycles with hardly any loss of capacity. This makes these batteries particularly durable.

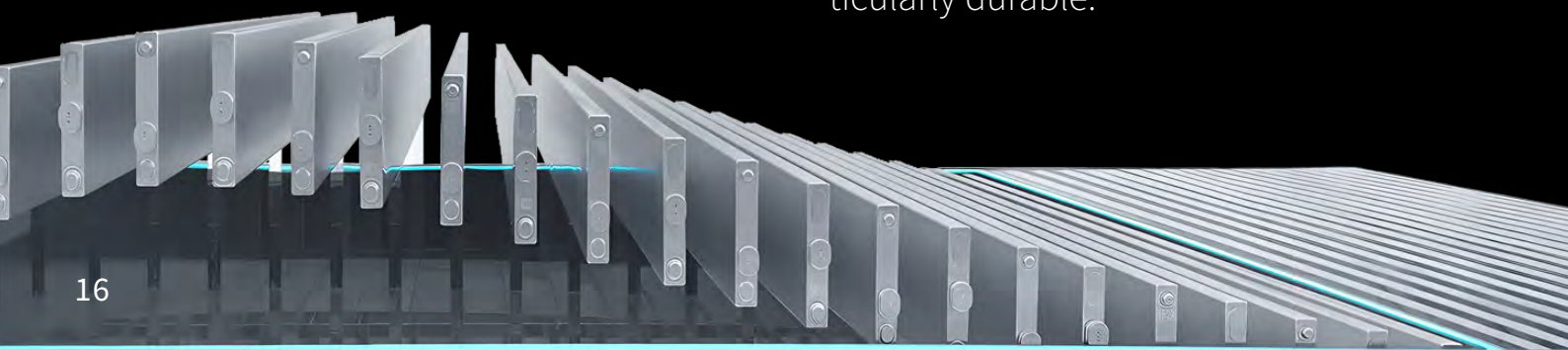

More space and range

The space utilisation of the Blade Battery has been increased by more than 50% compared to the traditional battery packs. By doing so, BYD has been able to increase the number of cells in the battery, resulting in improved energy density and greater range. Nevertheless, with a height of only 110 mm for the entire battery pack, the Blade Battery contributes to the efficient vehicle packaging and optimised interior space of the BYD SEAL. For example, despite its aerodynamic and sloping roofline, the BYD SEAL offers sufficient headroom for adult passengers in the rear.

Nail Penetration Test

The exceptional safety level of the Blade Battery is demonstrated by exceeding the requirements of the so-called Nail Penetration Test. This is the most rigorous way to test battery thermal runaway and simulates the consequences of a serious road accident. During the test, where the battery was literally pierced with a nail, the Blade Battery emitted no smoke and didn't catch fire at all. It also endured other extreme test conditions, such as crushed, bent, heated to 300°C and overloaded by 260%. None of these resulted in a fire or explosion, making BYD Blade Battery a safety leader in the EV market.



8-in-1 electric powertrain

As part of the advanced e-Platform 3.0, the BYD SEAL uses the innovative 8-in-1 electric powertrain, which integrates eight key components for propulsion, charging, control and management.

The world's first mass-produced 8-in-1 electric powertrain is highly integrated, which improves space utilisation and reduces weight. This technology also enables BYD to create exceptional opportunities for vertical integration within the supply chain. The eight integrated components are:

1. Vehicle Control Unit (VCU)
2. Battery Management Unit (BMU)
3. Motor Control Unit (MCU)
4. Power Distribution Unit (PDU)
5. DC-DC controller
6. On-board charger
7. Drive motor
8. Transmission

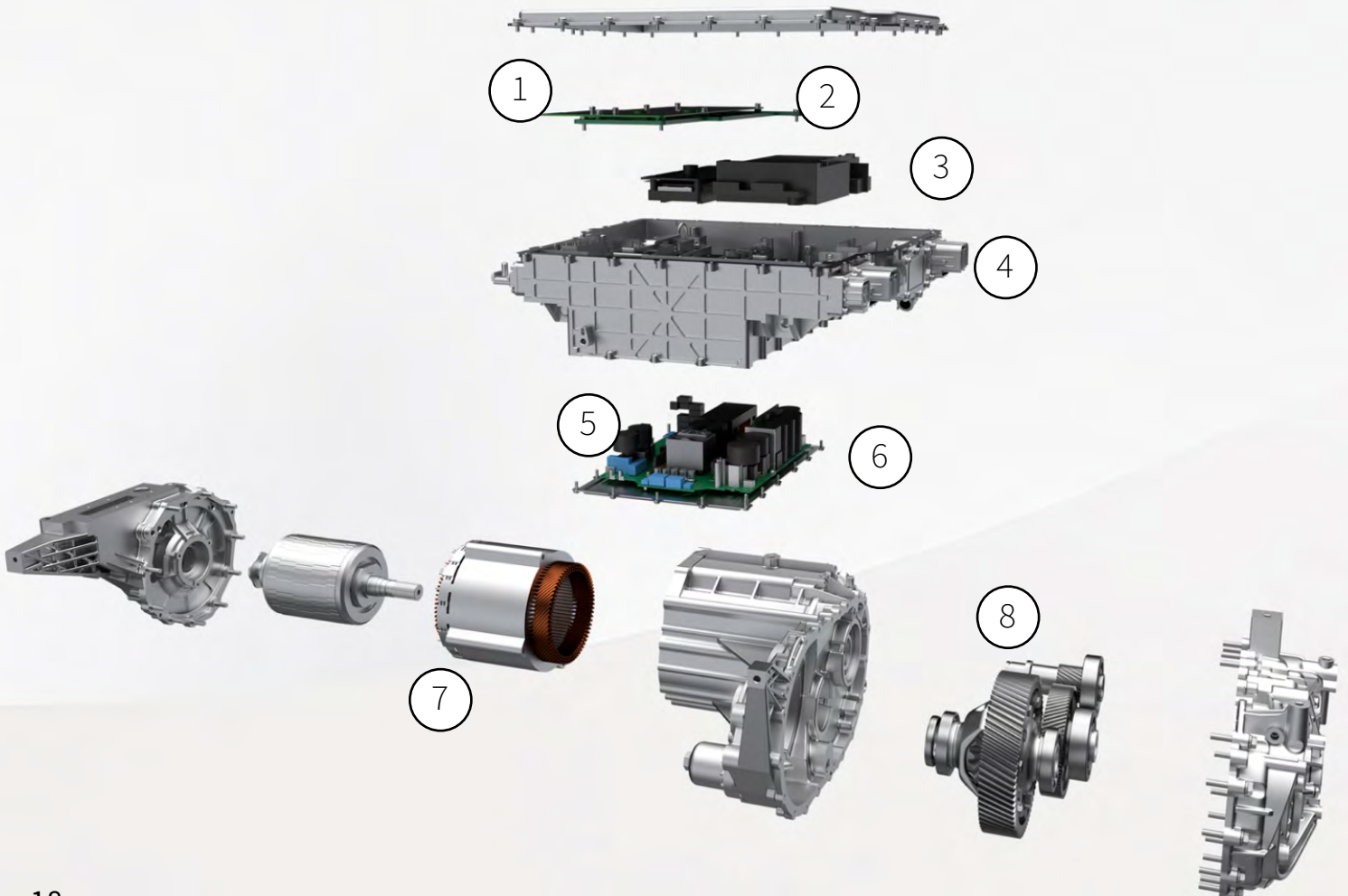



Heat pump

To optimise efficiency and increase range in all circumstances and weather conditions, the BYD SEAL also integrates an high-efficiency heat pump air-conditioning system as standard. This allows for efficient regulation of the battery temperature via direct cooling and direct heating of the refrigerant, increasing the thermal efficiency by up to 20% while reducing energy loss.

The heat pump can withstand temperatures ranging from -30°C to 60°C . Additionally, tests have proven that the heat pump can increase the range by up to 20% in winter conditions, since

the system leverages the residual heat from surroundings, the powertrain, passenger compartment and even the batteries. It can also control the passenger compartment temperature with low energy consumption.

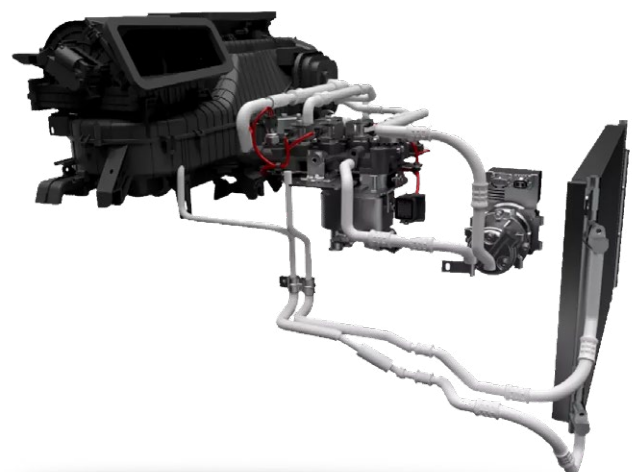

INTELLIGENCE

Smart driving aids

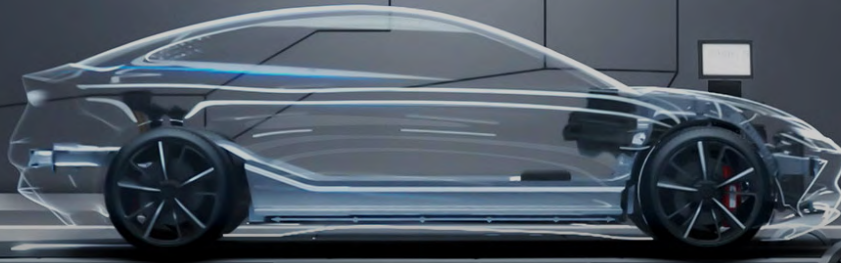

The progressive nature of BYD and the BYD SEAL goes beyond the e-Platform 3.0 with its advanced Cell-to-Body technology, Blade Battery and 8-in-1 powertrain. The BYD SEAL also offers a wide range of smart driving aids, varying from a newly developed Intelligent Torque Adaption Control system to a comprehensive range of advanced driver assistance systems (ADAS), as well as BYD's DiLink intelligent network connection system.

Driving dynamics

As a purebred, high-performance sports sedan, the BYD SEAL raises the bar in terms of driving dynamics and handling. Apart from the exceptional rigidity of the Cell-to-Body construction and the low center of gravity of the Blade Battery contributing to the high-quality handling, the SEAL is the first BYD with independent suspension with double wishbones at the front and a five-link rear suspension. In the case of the AWD version, you can even rely on semi-active suspension technology with frequency variable damping shock absorber for ultimate responsiveness, also known as Frequency Selective Damping (FSD) technology.

These advanced shock absorbers control the oil flow in the damper cylinder through the FSD valve. The damper cylinder automatically adjusts its softness and hardness according to the current pavement conditions.

In smooth road conditions, the damper cylinder has a greater damping resistance, for a more stable and maneuverable ride. On bumpy roads with a high vibration frequency, the damper becomes softer, which enables the damper cylinder to absorb the road impact, thus providing a comfort driving experience.

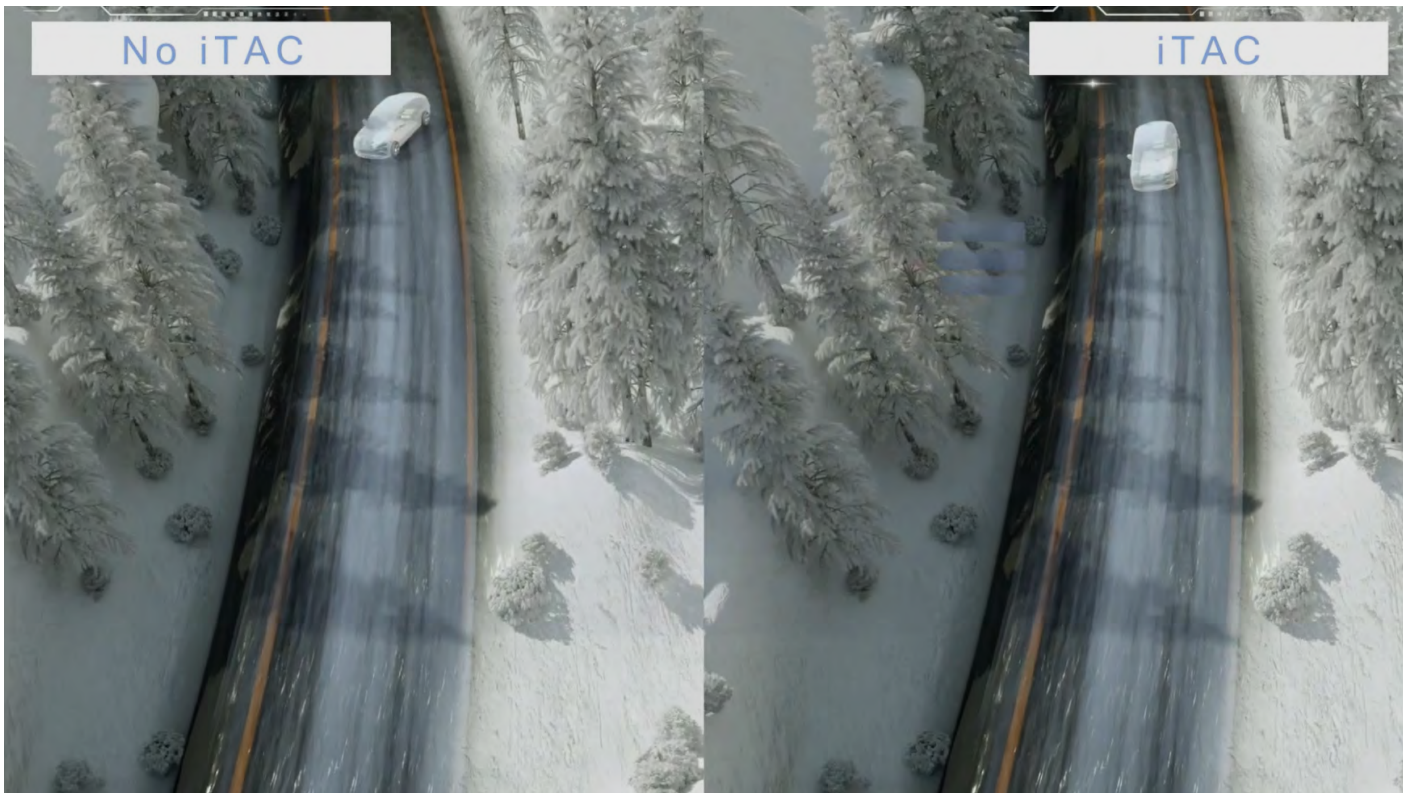

With and without iTAC.

iTAC

In addition to the intelligent suspension system, the BYD SEAL benefits from a newly developed Intelligent Torque Adaption Control system (iTAC). This software-driven technology has superseded the old method of restoring vehicle dynamics by only lowering the power output with various control methods, such as torque shift, appropriate torque reduction or negative torque output. Due to the increased recognition speed and change in adjustment methods, iTAC can integrate the vehicle's own state, as well as the driver's horizontal and vertical control needs and advance power distribution and adjustment, fully utilising the vehicle's power potential.

Driving modes

The BYD SEAL offers four distinct driving modes, catering to a variety of driving preferences and conditions. These modes include:

- ECO mode, which prioritises energy efficiency and extends the driving range.
- Normal mode, providing a balanced driving experience for everyday use.
- Sport mode, emphasising performance through aggressive acceleration and sharper handling.
- Snow mode, designed to enhance traction and stability on slippery surfaces like snow or ice.

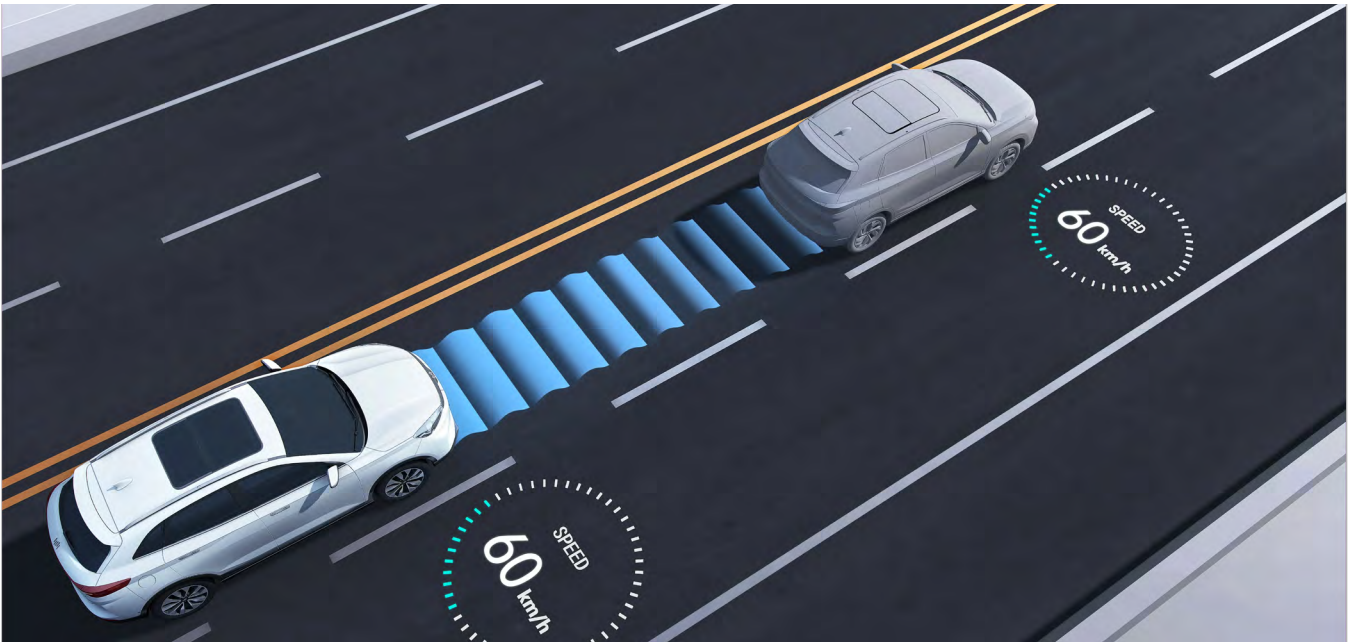

Advanced driver assistance

At BYD, safety is of paramount importance. This isn't just proven by the extensive passive safety measures, including the use of exceptionally strong steels and Cell-to-Body technology that contribute to the vehicle's unparalleled stiffness. The BYD SEAL also impresses in the field of active safety systems, given

the strikingly comprehensive range of advanced driver assistance systems (ADAS) for optimum safety and extra peace of mind while driving.

Examples include Forward Collision Warning, Automatic Emergency Braking, Adaptive Cruise Control, Lane Departure Assistant, Rear Cross Traffic Alert,

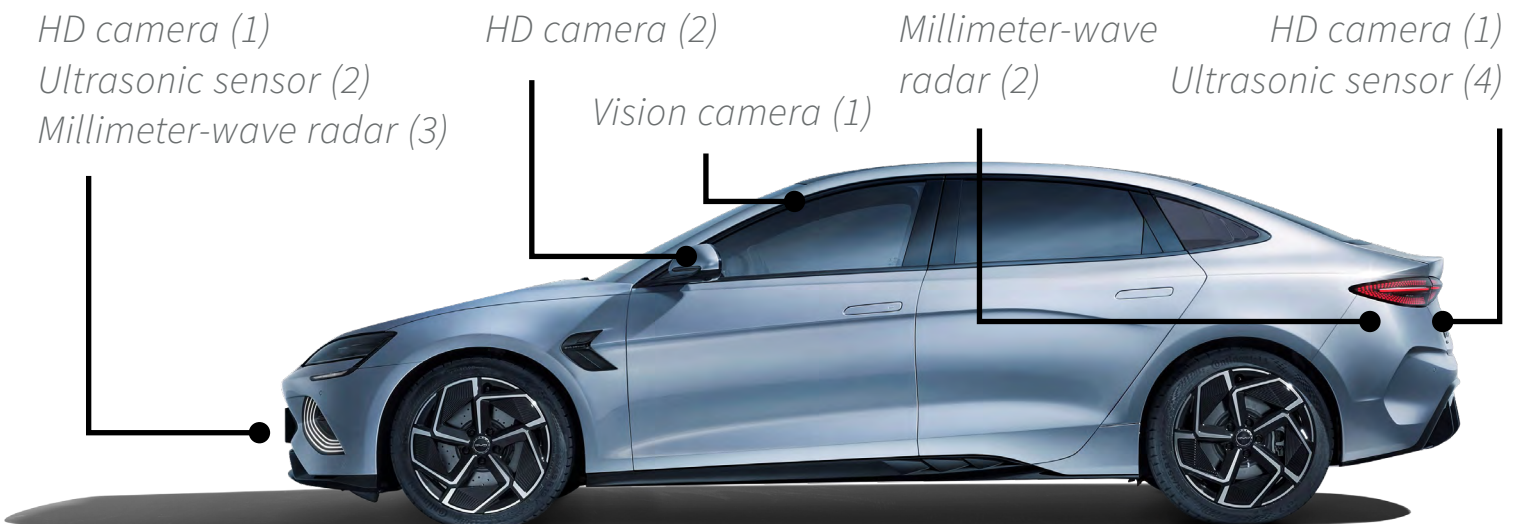

Emergency Lane Keep and Emergency call. Parking and manoeuvring in tight spaces is made easier thanks to the 360-degree panoramic camera with bird-view all-round visibility. Meanwhile, cutting-edge LED headlight technology provides a wider beam to aid visibility during night driving, including high beam assist, adaptive headlights and Follow Me Home as standard.

Intelligent Cockpit System

Smart connectivity and leading infotainment are other primary elements of the BYD SEAL. It features the BYD Intelligent Cockpit System, which is independently developed through software and hardware innovation, based on the latest technologies and user insights for an effortless connected experience. The

BYD Intelligent Cockpit System is operated by a 15.6-inch rotatable screen, with which you can choose whether you want the screen in landscape or portrait format, while a variety of driver information is displayed on the 10.25-inch full instrument LCD panel. The system also offers a 4G connection, integrated Spotify and HERE navigation, seamless smartphone integration via Android Auto or Apple CarPlay and intelligent voice control that can be activated with the voice command “Hey BYD”.

Furthermore, infotainment features are always up-to-date thanks to Over The Air (OTA) updates, while occupants are treated to a premium quality sound experience with the impressive 12-speaker Dynaudio Performance Audio System.



PERFORMANCE

True sports sedan

The BYD SEAL is offered with a choice of two powerful and highly efficient drivetrains, both with the same Blade battery with a capacity of 82.5 kW·h.

RWD or AWD

Firstly, BYD offers a single-motor version with rear-wheel drive (RWD) and a power output of 230 kW (313 PS). This version accelerates from 0-100 km/h in 5.9 seconds while its maximum range is set at 570 kilometres according to the WLTP combined cycle.

The BYD SEAL is also available with four-wheel drive (AWD) with an electric motor on the front and rear axles (160 kW + 230 kW), resulting in a total power output of 390 kW (530 PS). This powerhouse, and the first to combine AWD within the e-Platform 3.0 architecture, accelerates from 0-100 km/h in just 3.8 seconds. Due to its higher power output, the range is set at 520 kilometres (WLTP combined). Both the RWD and AWD versions are electronically limited to a top speed of 180 km/h.

Fast charging

The BYD SEAL is equipped as standard with a high-voltage boost charging

230 kW electric motor on the rear axle for both drive variants

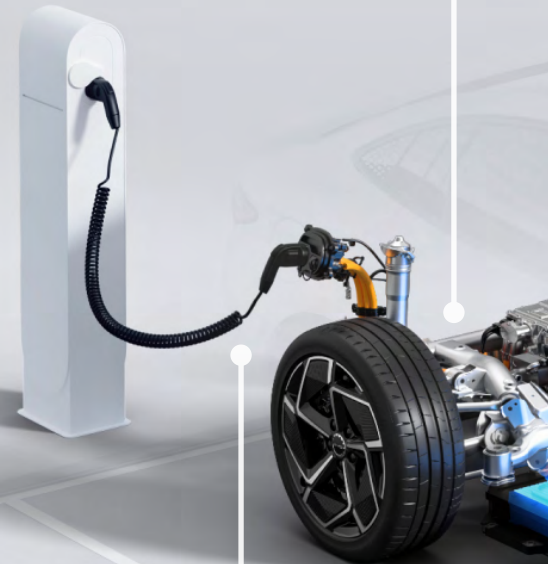

11 kW 3-phase AC charger and 150 kW DC charging capacity as standard

solution, which allows for faster charging. This technology innovatively uses the motor inductor to replace the boost inductor in the original boost solution, to meet the 420-750V voltage range of charging piles with high-power DC charging. During the charging process, the BYD SEAL reduces the heat generation of the charging and distribution assembly for more reliable performance. Therefore, it can make full

use of the charging current limit to achieve a wide band of constant power charging.

The BYD SEAL offers an 11 kW 3-phase on-board charger for AC charging as standard. The battery can also be topped up at a ultra-fast DC charging station with a capacity of up to 150 kW, allowing the battery to charge from 30% to 80% in just 26 minutes.

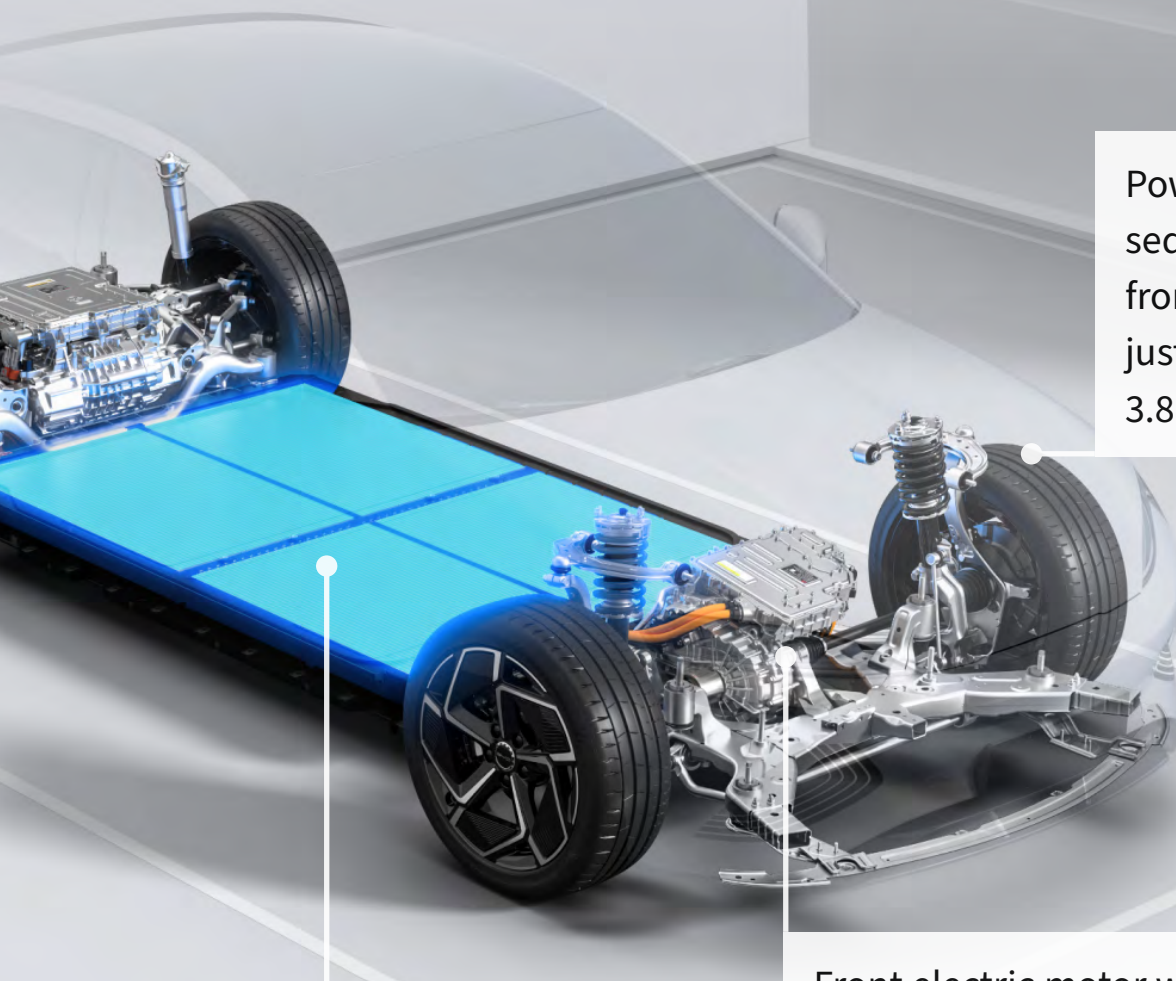

Powerful sports sedan accelerating from 0-100 km/h in just 5.9 (RWD) of 3.8 seconds (AWD)

82.5 kW·h Blade Battery provides up to 570 km range (WLTP)

Front electric motor with 160 kW, exclusively for the AWD version

SPECIFICATIONS

Design & Excellence-AWD

Exterior

- Panoramic roof
- Electric hidden door handle
- Front trunk with cover (53L)
- Electric tailgate
- Twin colour aluminium alloy wheel
- 235/45 R19 tyres
- LED headlights
- Automatic headlights
- Rear foglight
- LED daytime running light
- Follow me home (The headlights turned on in advance & delayed off function)
- Cut-through rear taillights
- High beam assist
- Electric heated defroster rear wind-shield
- Front rain sensor wiper
- Thermal insulation privacy glass rear electric door window
- Metallic paint
- Electric adjustment, electric defrosting, reverse auto-tilt, electric & automatic folding, position memory, side turn lamp, foot light & blind spot indicator
- License plate light
- LED rear light
- Front drilled ventilated disc
- Rear ventilated disc
- Front fixed calipers
- Thermal insulation, sound proofing & double glazed front electric door window



Waterdrop-shaped taillight



Integrated sport seats

Interior

- Leather, multi-function with heating steering wheel
- 10.25-inch LCD main dashboard display
- Dashboard material: slush-molding plastic
- Wireless charging 15W (2 units)
- 1 × Type-A (18W) + 1 × Type-C (60W) front
- 1 × Type-A (18W) + 1 × Type-C (60W) rear
- Visor with illuminated vanity mirrors: driver & passenger
- Knitted fabric car roof lining
- Front & rear centre armrest
- 2 × front & 2 × rear cup holders
- Metal side sill plate
- 12V power output
- 2 + 3 seat number layout
- Split folding rear seats - 40:60
- Leather seat upholstery
- Driving seat: electric adjustment (8D), electric lumbar support adjustment (4D), ventilation, heating, position memory & integrated headrest
- Front passenger seat: electric adjustment (6D), ventilation, heating & integrated headrest
- Rear seats: manual adjustment of headrests
- Interior light: tailgate light, glove box light, LED front reading light & LED

rear reading light

- Door lights
- Ambient light: multi-colour gradient, all doors, dashboard & front foot space
- Automatic anti-glare interior rear-view mirror
- Auto air conditioning
- Dual air conditioning zone
- Foot & face rear air vent
- PM2.5 air filter
- Negative-ion generator
- Heat pump

Safety

- Driver's airbag
- Front passenger's airbag with deactivation switch
- Front centre airbag
- Front-side airbag
- Rear-side airbag
- Left-side air curtain
- Right-side air curtain
- Front seat belts: pre-tensioned & height adjustable
- Rear seat belts: pre-tensioned seat belt
- Seat belts warning (all seats)
- 360° camera
- Blind Spot Detection (BSD)
- Heads-up Display (HUD) (only for AWD)
- 2 × Front parking radar



Panoramic sunroof

- 4 × Rear parking radar
- Direct Tire Pressure Monitoring Systems (TPMS)
- Electronic child safety lock
- 2 × I-size FIX in rear seats & 1 × I-sizeIX in front passenger seat
- Emergency call (E-Call)
- Intelligent power braking system
- Hydraulic power brake system & Hydraulic brake assist
- Traction Control System (TCS)
- Parking brake deceleration control
- Vehicle Dynamic Control System (VDC)
- Automatic vehicle hold
- Electric parking brake system
- Hill start control system
- Comfort brake system
- Door Open Warning (DOW)
- Driver Attention Warning (DAW)
- Alcohol Detection System (ADS)
- Child Forgetting Detection (CFD)

Driving Assistance

- Adaptive Cruise Control (ACC) & Intelligent Cruise Control (ICC)
- Intelligent Speed Limit Information (ISLI) & Intelligent Speed Limit Control (ISLC)
- Predictive Collision Warning (PCW)
- Forward Collision Warning (FCW)
- Automatic Emergency Braking (AEB)
- Rear Collision Warning (RCW)
- Front Cross Traffic Alert (FCTA) & Front Cross Traffic Brake (FCTB)
- Rear Cross Traffic Alert (RCTA) & Rear Cross Traffic Brake (RCTB)
- Lane Departure Assistant (LDA) & Lane Departure Warning (LDW)
- Emergency Lane Keeping Assist (ELK)
- Traffic Jam Assist (TJA)
- Traffic Sign Recognition (TSR)



Rotatable touchscreen



Crystal gearshift lever



53-litre frunk with cover



12-speaker Dynaudio Audio System

Convenience & Efficiency

- Remote climate control
- Keyless system entry
- Steering wheel adjustment (manual 4-way)
- Electronic Parking Brake (EPB)
- Automatic Vehicle Hold (AVH)
- NFC card (1 pcs)

Infotainment

- FM/DAB+ radio
- 15.6-inch Intelligent-rotate Screen
- OTA function
- Internet of vehicles (4G)
- 12-speaker Dynaudio® sound
- BYD voice control assistant - "Hi BYD"
- Cloud service ¹
- Apple Carplay® / Android Auto®

¹ 10 years free cloud service; 1GB data for infotainment per month for free in first 2 years.

SPECIFICATIONS

Technical data

Driving Performance	Design	Excellence-AWD
Electric Motor Type	Rear: Permanent magnet synchronous motor	Front: Asynchronous motor Rear: Permanent magnet synchronous
Drive Type	RWD	AWD
Drive Mode	Sport, normal, economic & snow	
Max. power (kW)	230	390
Max. torque (Nm)	360	670
Acceleration 0-100 km/h (s)	5.9	3.8
Top speed (km/h)	180	
Front suspension	Double wishbone suspension	
Rear suspension	Multi-link (5 links)	
Front - Frequency variable damping shock absorber	—	●
Rear - Frequency variable damping shock absorber	—	●

Vehicle Weight & Capacity	Design	Excellence-AWD
Kerb weight (kg)	2,055	2,185
Min. turning circle (m)	5.7	
Luggage compartment volume (L)	Front trunk: 53 Rear trunk: 400	

Battery

Battery type	Blade Battery (LFP)	
Battery capacity (kW·h)	82.5	

Battery position	Under floor
Battery coolant circulation	●

WLTP Consumption	Design	Excellence-AWD
Electric range - combined (km) ¹	570	520
Electric range - city (km) ¹	690	600
Consumption - combined (kW·h/100km)	16.6	18.2
Consumption - city (kW·h/100km)	13.8	15.8
CO ₂ Emissions - combined (g/km)	0	

Charging Power & Time

Charging port	CCS2
AC charging power (kW)	11
DC charging power (kW)	150
DC charge (150 kW charger) SOC 10%-80% ²	37 min
DC charge (150 kW charger) SOC 30%-80% ²	26 min
Appointment charging System	●
Vehicle-to-Load power (kW)*	3

* Vehicle-to-load cable standard for Excellence-AWD. Optionally available for Design.

1. The electric range may be different with the real driving results as the range will depend on a variety of factors including driving styles, traffic condition, weather, and temperature.

2. The figures for charging time listed are calculated at an ambient temperature of 30°C and may vary depending on the ambient temperature and battery temperature.

DIMENSIONS

SEAL body size

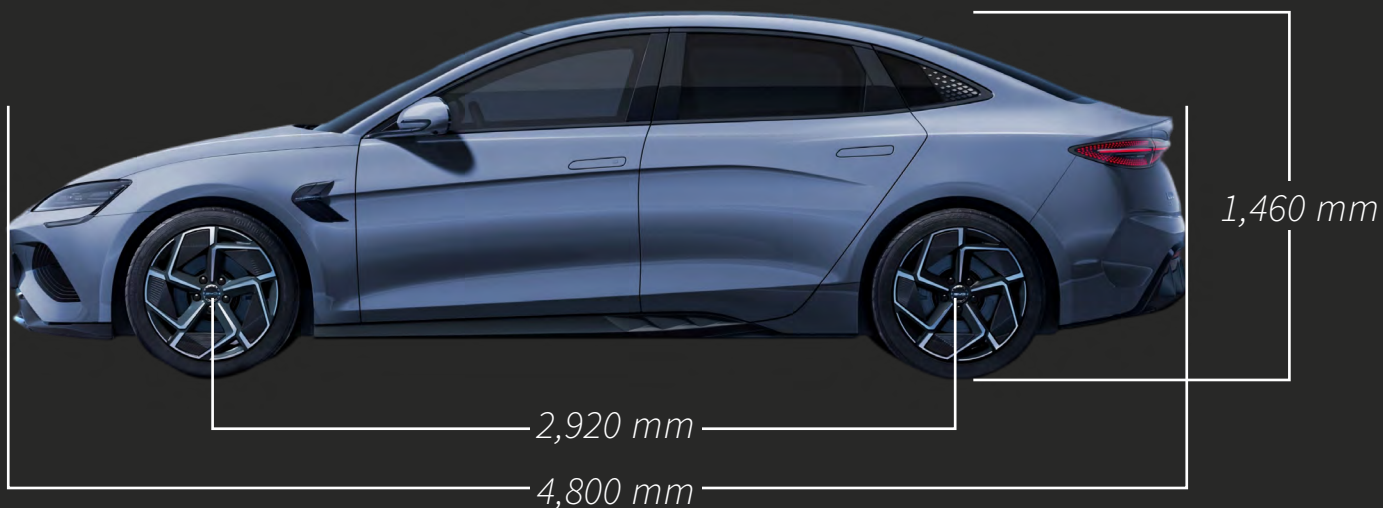

COLOURS

Exterior



Body colour	Design	Excellence-AWD
Indigo grey	€1,500	€1,500
Shadow green	€1,500	€1,500
Ice blue	•	•
Polar white	•	•
Space black	•	•
Atlantis grey	•	•

• Standard

Interior



Tahiti blue



Black

SEAL Price List

Model Description	Drive	Wheel	VRT Band %	Road Tax	KW	Retail Price	VRT Relief	SEAI Grant	Delivery	Subsidised Retail Price
SEAL DESIGN	RWD	19"	7%	€120	230	€50,025	-€2,489	-€3,500	€1,950	€45,986
SEAL EXCELLENCE	AWD	19"	7%	€120	390	€54,025	-€689	-€3,500	€1,950	€51,786

Prices applicable on registrations until 31/5/2024.

SRP = Subsidised Retail Price after state subsidies for private customers of VRT rebate and SEAI grant (Sustainable Energy Authority of Ireland).

BYD North Dublin

BYD South Dublin

BYD Cork

www.msl.ie

Please note prices applicable to all models registered until 31/5/2024. Subject to availability. Terms & Conditions apply. Prices quoted do not include dealer and delivery related charges. All details on this website should be regarded as approximate. The manufacturer reserves the right to make changes to design, specification, terms and conditions governing new vehicle sales, and prices. Information on prices and standard equipment, statutory and legal requirements, including tax legislation, applies to the Republic of Ireland only. Illustrations may also depict accessories or special equipment that are not part of the standard delivery specification. Images shown throughout the site are a general indication of the model and therefore some images are for illustrated purposes; features, equipment and colours may not be available in the Republic of Ireland or may not be to the Republic of Ireland specification. Prices applicable are those ruling at date of delivery. This list cancels all previous lists and the prices are ex distribution compound and exclude delivery and other related charges and service contract. Prices are subject to alteration at any time without notice or obligation. While every effort is made to ensure accuracy, no responsibility can be accepted by Motor Distributors Limited or any of its Authorised Agents for errors, omissions or alterations.

Battery Electric Vehicles (BEV) figures determined with battery fully charged. These models require mains electricity for charging. Figures shown are for comparability purposes only. Figures may differ from real life driving results, which will depend upon a number of factors including (a) the starting charge of the battery (b) accessories fitted (post registration), variations in weather, driving styles and vehicle load.

BYD



BYD Ireland

www.bydauto.ie

All information and illustrations are based on data available at the time of print (September 2023) and are subject to change without prior notice. Please contact your local BYD dealer for the latest information