



The EQS

Price List as of 1st July to 31st August 2024

MERCEDES-EQ



Welcome

At Mercedes-Benz we appreciate the importance of detail. Over the following pages you'll find model prices and a breakdown of standard and optional equipment, as well as details of the attractive finance offers and benefits that are available to every Mercedes-Benz driver.

We have highlighted some of the best styling features both inside and out, some of the new technology features and some body styling options which all combine to give you a unique driving experience. To experience a full listing of what is available; please speak directly to your local Mercedes-Benz Dealer.

Of course, some things have to be experienced to be truly appreciated, such as the qualities that set a Mercedes-Benz apart, which is why we'd like to invite you for a test drive at your local Mercedes-Benz Dealership. Discover the location and the contact details of your local Mercedes-Benz Dealership at **www.mercedes-benz.ie**



Some of the model features, optional extras and colours shown may not be available, or may only be available in a different specification, or at a different price.

Price List

Electric drive

Model Description	Wheel size	CO2	VRT Rate	Road Tax	Range WLTP	BHP	Price*
EQS 450+ AMG Line	20"	0	7%	€120	738	360	€128,720
EQS 450 4MATIC AMG Line	20"	0	7%	€120	702	360	€132,855
EQS 500 4MATIC AMG Line	20"	0	7%	€120	702	449	€143,660
MERCEDES-AMG EQS 53 4MATIC	21"	0	7%	€120	568	658	€176,960

*Prices applicable to all models registered from 1st July to 31st August 2024 . MY804 stock in the country. Subject to availability. Terms & Conditions apply. Prices quoted do not include dealer and delivery related charges.

Owing to supply shortages, options for vehicles may be temporarily restricted, resulting in modified vehicle and/or package pricing . Regularly updated information on this issue is available from Mercedes-Benz dealers.





Some of the model features, optional extras and colours shown may not be available, or may only be available in a different specification, or at a different price.



Some of the model features, optional extras and colours shown may not be available, or may only be available in a different specification, or at a different price.



EQS



Sustainability

Sustainable production.

The roof of Factory 56, EQS's production facility, is equipped with 12,000 photovoltaic modules. These have a maximum output of around 5,000 kWp and can thus cover around 30% of the factory's energy needs on an annual average. All in all, the energy requirement of Factory 56 is 25% lower than that of other assembly buildings. The bottom line is that Factory 56 will be a zero-carbon factory – completely CO₂-neutral.



Sustainable materials.

To ensure the responsible mining of cobalt, lithium and other battery raw materials, Mercedes-Benz has already made the IRMA Standard for Responsible Mining a contractual component for all future vehicle projects.

Sustainable mobility.

Locally emission-free driving pleasure, virtually silent with full access to inner city zones. All our EQ vehicles come as standard with an external acoustic warning to alert pedestrians or cyclists at speeds under 19 mph.





EQS

Technology

Mercedes me connect

Stay connected any time, anywhere.

Mercedes *me*

Mercedes me is a range of innovative online services designed to enhance your Mercedes-Benz experience. Accessible via mobile, tablet or PC, Mercedes me lets you enjoy the highest standards of care and support, in a way that integrates seamlessly with your busy lifestyle.

Safety and Service – Mercedes me connect helps to keep you and your car safe

Check your car's washer fluid level, tyre pressure and battery level from your phone so you'll be ready for every journey.

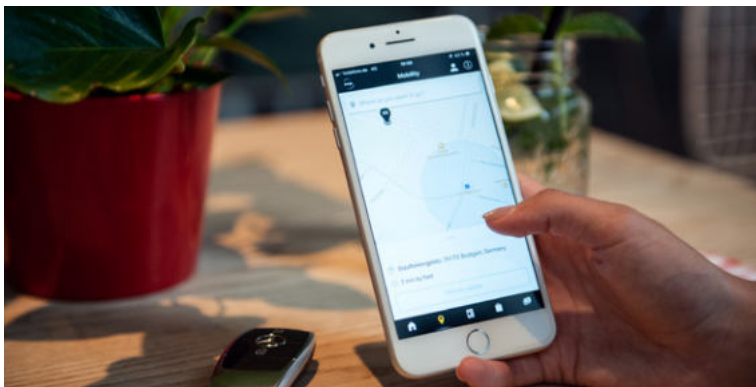

Live Traffic Information, Parked Vehicle Locator and much more with Mercedes me connect

Forgot where you've parked? Parked Vehicle Locator¹ will show you exactly where your car is as long as you're in a 1.5 km radius of where you parked. Real-time traffic data and dynamic route with shorter journey times.

For more information speak to your local Retailer or visit the Mercedes me connect store at <https://shop.mercedes-benz.com/en-ie/connect/>

Comfort – connect to your car anytime, anywhere

Forgot to lock your car? With Remote Car Lock² you will receive a notification on your smartphone to let you know. With one tap, you can lock and unlock your vehicle so you never have to worry.

EQ-specific Services

Check your charging status on the go and programme your pre-entry climate control and charging settings remotely. The EQ-specific navigation considers electrical range, topography and charging stations.

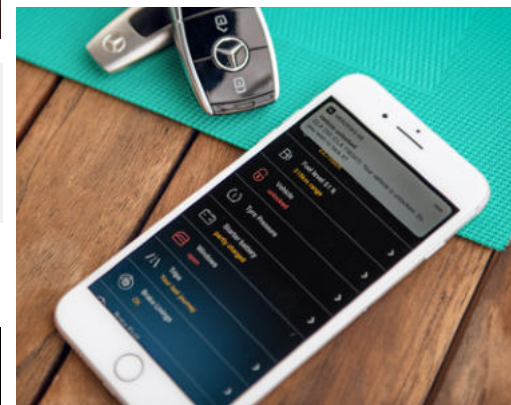

¹Available on all models with the Vehicle Monitoring package. This option may vary between standard and additional cost dependent on the model

²Part of the Vehicle Status package. This option may vary between standard and additional cost dependent on the model

Images shown are for illustration purposes only

Mercedes-Benz User Experience (MBUX)

Transforming the in-car user experience, thanks to MBUX: Controlled via voice, touch or gesture (where fitted) input, the innovative infotainment system can over time even predict personal habits thanks to artificial intelligence.

Voice control

- Activated by the keywords “Hey Mercedes”, the new intelligent voice control LINGUATRONIC¹ lets you control many of the infotainment functions, including destination input, phone calls or music selection
- MBUX is able to understand different accents and will adjust to you over time
- MBUX even understands indirect commands. Feeling chilly? Just say “I feel cold” and MBUX will adjust the temperature for you
- MBUX is able to understand which individual seat the request has come from, and will therefore only respond to their specific request (e.g. adjusting the temperature for just the left rear occupant)

Touch inputs

- Beside voice control you can operate MBUX via touchscreen, the touch controls on the centre console, as well as touch control buttons on the steering wheel
- The touchpad recognises your handwriting should you wish to enter addresses or phone numbers silently

Personalisation

- Turn the new EQS into your very own Mercedes-Benz by personalising driving modes, radio stations, ambient lighting and much more
- Your personal settings can be saved in up to seven different profiles, making your driving experience the best one possible
- Thanks to artificial intelligence, MBUX is able to learn and adapt over time. It will be able to predict your personal habits, such as navigation for frequently-driven routes, or the radio station you like to listen to on your way home from work

Maintenance and service

- Wondering when the next service is due? Or how much further you can drive until you need to stop at a charging station? Just ask your MBUX – it will tell you the answer



MBUX multimedia system

¹LINGUATRONIC off-board functions are currently only available for three years

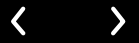

EQS

Safety

DIGITAL LIGHT

High-definition headlamps with innovative features

The new innovative DIGITAL LIGHT headlamps works like a projector with more than one million pixels per headlamp and responds with brilliant light to changing traffic, road or weather conditions. Its ULTRA RANGE Highbeam with 650 m makes you feel like driving at daylight.

Available with Advanced Plus Package, Premium Package & Premium Plus Package



Driving Assistance package Cares for what matters.

The new EQS comes with standard ground-breaking innovations in safety, comfort and driving functions, to help you stay safe on the road.

Driving Assistance package (Standard)

Blind Spot Assist

Active Distance Assist DISTRONIC now responds to stationary road users to prevent collisions up to 130 kph

Active Lane Keeping Assist with enhanced comfort thanks to active steering intervention (instead of braking intervention) and additional hazard indication



Active Lane Keeping Assist

Driving Assistance package Plus (Component of Advanced Plus Package & Premium Package & Premium Plus Package)

Active Distance Assist DISTRONIC: now responds to stationary road users to prevent collisions up to 130 kph

Active Steering Assist: Active Steering Assist offers you tangible added comfort at the wheel: the system can use gentle steering interventions to support you in guiding your vehicle in the centre of the lane. This ensures a high degree of stress relief in particular on monotonous routes with a straight or slightly curved carriageway.

Active Lane Change Assist

Active Lane Keeping Assist: with enhanced comfort thanks to active steering intervention (instead of braking intervention) and additional hazard indication

Blind Spot Assist

Active Speed Limit Assist: More safety, less stress. The Active Speed Limit Assist helps you to observe the stipulated maximum permissible speed – even in unclear situations. The system is able to detect speed limits and helps to ensure that your vehicle speed is automatically adjusted to such limits in an anticipatory manner.

Evasive Steering Assist: with bicycle, pedestrian and end of tailback detection

PRE-SAFE® PLUS and Impulse Side with body-raising function: when a rear-end collision threatens, PRE-SAFE® PLUS can initiate preventive measures, including warning following traffic and locking the brakes on standstill

Traffic Sign Assist Maintains orientation: thanks to intelligent linking of camera and map data, Traffic Sign Assist is not only able to detect maximum permissible speeds, overtaking restrictions and when they are lifted. It is additionally able to respond to red traffic lights, stop signs and no-entry restrictions and warn you to prevent you from inadvertently driving through a stop sign or no-entry sign.



Active Distance Assist DISTRONIC

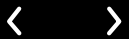

EQS

Mercedes-EQ



EQS

MERCEDES-EQ

Vehement power immediately from standstill: An electric motor at the rear axle converts electrical into mechanical energy, and delivers impressive forward thrust. The intelligent operating strategy of the powertrain components supplies the power always wherever it is needed at the moment – efficiently and nearly silently.

EQS 450+

Battery electric vehicle, 360 hp/245 kW
Electric range 729–740 km – WLTP¹

EQS 450 4MATIC

Battery electric vehicle, 360 hp/265 kW
Electric range 694–704 km – WLTP¹

EQS 500 4MATIC

Battery electric vehicle, 449 hp/330 kW
Electric range 694 – 704 km – WLTP¹

Mercedes-AMG EQS 53 4MATIC+

Battery electric vehicle, 658hp/484 kW
Electric range 572 km – WLTP¹



Standard equipment

AIRMATIC air suspension

Charging system – AC charging system rated at 11 kW AC

Charging system – DC charging system rated at 110 kW DC

Charging socket

Charging cable for wallbox and public charging stations, Type 2 (Mode 3) – 5 m

Charging cable for domestic plug socket, Type G (Mode 2) – 5 m

Pre-entry climate control

Radar-based recuperation





Technical details

Electric range ¹	569–761 km	
Charging time	Public Rapid charger (200 kW DC) 10–80% ²	31 mins
	Wallbox (11 kW AC) 10–100% ²	10 hrs
	Home wallbox (7.4 kW AC) 10–100% ³	15 hrs 30 mins
Range power consumption, combined ^{1,2}	193–170 Wh/km	
Battery type (capacity)	lithium-ion (107.8 kWh)	
Capacity on-board charger	11 kW AC; 200 kW DC	

Attention

 Please be aware that external factors such as weather, gradient and ambient temperature amongst others can significantly impact range.

 Please also note that internal factors such as driving style and climate control settings etc. can also significantly impact range.

 Using the pre-entry climate control when plugged into a charge point will ensure the perfect ambience and ensure that your car is just how you like it, as well as making sure that your battery isn't used unnecessarily to heat/cool the vehicle (maximising range).

¹Figures shown are for comparability purposes; only compare with other cars tested to the same technical procedures. Figures may not reflect real life driving results, which will depend upon a number of factors including the starting charge of the battery, factory-fitted options, accessories fitted (post registration), variations in weather, driving styles and vehicle load ²Specified voltage and current values refer to network infrastructure and can be limited by the vehicle. Times are from 10–100% charge using a wall box (three-phase) or home wallbox (single-phase) ³If you are planning to charge your Mercedes-Benz plug-in electric vehicle using a 3-pin domestic plug socket you must get a qualified electrician to inspect and sign off the socket to confirm it is safe and suitable to charge your vehicle. Do not use an electric vehicle 3-pin charge cable with an extension cord.

EQS Model lines overview

Standard



AMG Line Exterior »

The expressive styling of the AMG Line lends the exterior of your EQS an exciting, dynamic touch. Sporty AMG genes meet progressive luxury – a clear statement combining unique design with equally unique technology.

No cost option



Electric Art Exterior »

Luxury in its most progressive form: the Electric Art exterior particularly highlights the innovative design of your EQS. It is accentuated by high-grade chrome trim elements all-round. Even at standstill, impressive 20-inch light-alloy wheels signal superior performance.

EQS AMG Line Exterior



Exterior

20" AMG alloy wheels - 5-spoke design, aerodynamically optimised, painted in black with a high-shine finish (code RRP)

AMG front bumper painted in vehicle colour with A-wing in high-gloss black and trim in chrome, front splitter in high-gloss chrome with flics and fins at the left and right air inlets in high-gloss black with chrome trim

AMG rear apron painted in vehicle colour with diffuser-look inserts in high-gloss black, double trim strip in chrome and flics at the left and right air outlets in grained black

Headlamps - static LED headlamps with Highbeam Assist

KEYLESS-GO

Side skirts painted in high-gloss black with insert in chrome

Steering - 4.5° rear axle steering



EQS Electric Art Exterior



Exterior

20" 5-spoke light-alloy wheels, aerodynamically optimised, painted in black with a high-sheen finish. (Code R61)

Front apron with chrome trim in the upper and lower section

Side skirts painted in graphite grey with chrome inserts

Rear apron painted in the vehicle colour with lower section in graphite grey metallic and chrome trim

Headlamps – static LED headlamps with Highbeam Assist

KEYLESS-GO

Steering – 4.5° rear axle steering



EQS AMG Line Interior

equipment highlights

Option



Communications, Safety and Assistance Systems

12.3-inch driver display and MBUX multimedia system with 12.8-inch OLED central display

Driving Assistance package

MBUX augmented reality for navigation

Parking package with Parking Assist and reversing camera



Interior

AMG brushed stainless steel sports pedals with black rubber studs

AMG floor mats

AMG multifunction sports steering wheel in nappa leather

AMG sports seat in leather upholstery

Dashboard and beltlines in space grey ARTICO man-made leather with NEOTEX grain and red topstitching

Heated front and rear seats

Privacy glass

Roof liner in black fabric

Trim and Upholstery

Leather - black/space grey



Anthracite linestructure lime wood



EQS Electric Art Interior

equipment highlights

Standard



Communications, Safety and Assistance Systems

- 12.3-inch driver display and MBUX multimedia system with 12.8-inch OLED central display
- Driving Assistance package
- MBUX augmented reality for navigation
- Parking package with Parking Assist and reversing camera



Interior

Comfort seats with lumbar support, comfort head restraints in the front and contour lighting

Multifunction steering wheel in nappa leather with galvanised steering wheel shift paddles in silver chrome

Heated front and rear seats

Privacy glass

Roof liner in black fabric

Trim and Upholstery

Leather – black/space grey

Black fine structure-look trim



Upholsteries

Electric Art Interior - Lugano Leather



201A Black/Space Grey (Standard)



205A Macchiato Beige/Space Grey (Optional)



209A Neva Grey/Balao Brown (Optional)



211A Black/Balao Brown (Optional)

Upholsteries

Electric Art Interior - Nappa Leather



509A Neva Grey/Biscay Blue (Optional)

Requires Exclusive Nappa Leather Package + Multicontour Seats + Climatised Seats + Advanced Plus Package



519A Neva Grey/Reflex Blue (Optional)

Requires Edition 1 Package + Premium Package + Climatised Front Seats



801A Black/Space Grey (Optional)



805A Macchiato Beige/Space grey (Optional)

Requires Climatised Seats



811A Black/Balao Brown (Optional)

Requires Climatised Seats

Upholsteries

AMG Line Interior

Artico Leather / Microcut Fibre



651A Black/Space Grey (Standard)

Lugano Leather



229A Neva Grey/Balao Brown (Optional)

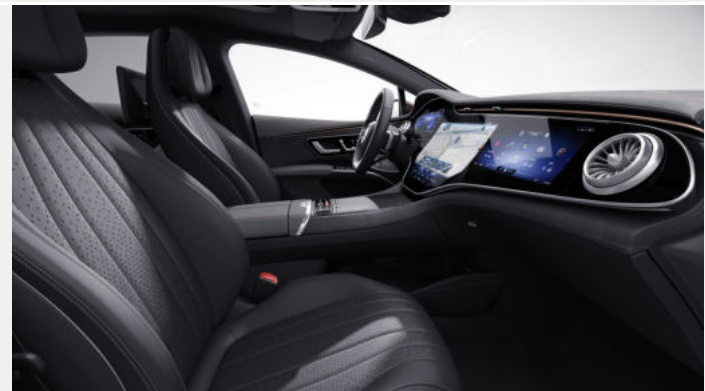

231A Black / Space Grey (Optional)

Trim options



H51 Black Fine Structure-look Trim
Standard with Electric Art Interior.



H08 Anthracite Linestructure Lime Wood Trim
Standard with AMG Line Interior.

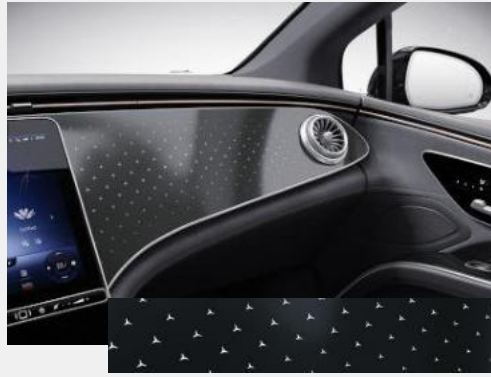

51H+331 Laser-cut Backlit Trim
Optional for AMG Line Interior.



H12 Brown Open-pore Walnut Wood Trim
Optional for AMG Line Interior.



H67 Anthracite 3D Relief-look Trim
Optional with AMG Line Interior.



07H Ship's deck open-pore Maple Wood Trim
Optional for AMG Line Interior & Electric Art Interior

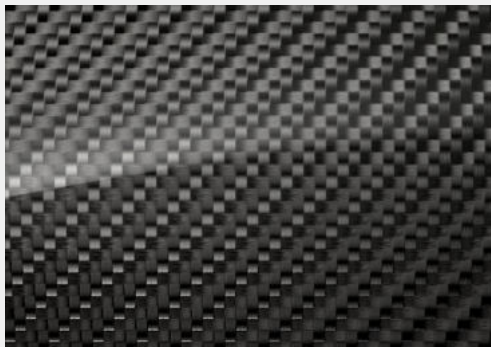

H73 AMG Carbon-Fibre Trim
Optional for AMG Line Interior & Electric Art Interior

Wheel options

20"



RRP (Standard)

5-spoke light-alloy wheels
Painted in black with a high-sheen finish, with aero elements in a high-gloss chrome star-look finish



RRU (Optional)

AMG 5-spoke light-alloy wheels
Painted in black, with aero elements in tantalum grey matt look



29R (Optional)

5-spoke light-alloy wheels
Painted in black with a high-sheen finish, with aero elements in a high-gloss chrome star-look finish



96R (Optional)

5-spoke light-alloy wheels
Aerodynamically optimized, painted in black with a high-sheen finish



R61 (Optional)

5-spoke light-alloy wheel
Aerodynamically optimized, painted in black with a high-sheen finish

21"



18R (Optional)

10-spoke light-alloy wheels
Aerodynamically optimized, painted in black with a high-sheen finish and energy blue metallic highlights,



19R (Optional)

5-spoke light-alloy wheels
Aerodynamically optimized, painted in black with a high-sheen finish,
Requires Electric Art Ext.



RWX (Optional)

AMG multi-spoke light-alloy wheels
Aerodynamically optimized, painted in black with a high-sheen finish,



RWY (Optional)

AMG multi-spoke light-alloy wheels
Aerodynamically optimized, painted in high-gloss black with a high-sheen finish,

22"



O0R (Optional)

5-twin-spoke light-alloy wheels
Aerodynamically optimized, painted in black with a high-sheen finish,

Colour options metallic & non metallic

● Standard

□ No-cost option

X Cost option



149 white non-metallic



197 obsidian black metallic



831 graphite grey metallic



771 velvet brown



346 onyx black metallic



842 sodalite blue metallic



595 nautic blue metallic



922 high tech silver metallic



Please note that, owing to limitations of on-screen representation, paint colours may differ from those shown

Colour options MANUFAKTUR

Standard No-cost option Cost option



885 MANUFAKTUR opalite white metallic X



993 MANUFAKTUR patagonia red metallic X



297 MANUFAKTUR selenite grey magno X

Please note that, owing to limitations of on-screen representation, paint colours may differ from those shown

Advanced Plus Package From¹ €6,376

Digital Light with Light Band

- HD system with projection module (more than 1.3 million pixels per headlamp) and background module MULTIBEAM LED
- With data from the camera, sensors and navigation system, the brightness value for each individual pixel is calculated virtually in real time
- Adaptive Highbeam Assist Plus (anti-dazzle continuous main beam)
- ULTRA RANGE Highbeam with more than 600 m range (legally permitted maximum headlamp range)
- Topographical compensation
- Cornering light with roundabout and junction functions
- Active light function with anticipatory control
- Enhanced fog light function, city light, country road mode, motorway mode, motorway main beam and adverse

Driving Assistance Package Plus

Taking you to your destination safely and relaxed: Thanks to modern, intelligently networked sensor systems you enjoy the various advantages of partially automated driving. Numerous driver assistance systems support you as the situation requires, warning you if there is a risk of collision and intervening if necessary – for the benefit of all road users.

Parking Package with 360° Camera

- 12 ultrasound sensors: 6 each in the front and rear bumpers
- 360° camera featuring 4 networked close-range cameras (in the radiator grille, integrated into the boot lid and in the outside mirror housings)



¹Price and availability subject to vehicle specification

Owing to supply shortages, options for vehicles may be temporarily restricted, resulting in modified vehicle and/or package pricing. Regularly updated information on this issue is available from Mercedes-Benz dealers.

Premium Package From¹ €13,569

In addition to/replacement of Advanced Plus Package components

Burmester® Surround Sound System

Experience greater audio performance with exquisite Burmester® sound. The high-quality speakers achieve impressive surround sound. You can specifically optimise this for the front and rear seats to intensify the listening experience. In addition the specially designed Sound Experience reinforces your electric driving experience in the interior. In all, 15 highly precise, high-performance speakers with a system output of 710 watts are fitted.

Head-Up Display

Ideal prospects for sporty driving pleasure and a superior driving experience: The head-up display transforms your windscreen into a digital cockpit. With the virtual, full-colour image, you always have a direct view of key information. Your full attention remains on the road and the traffic conditions in front of you.

Panoramic Sliding Sunroof

Whether open or closed, with the panoramic sliding sunroof you experience a wonderful feeling of freedom and enjoy a pleasantly bright ambience in the interior. When viewed from the outside, the large sliding sunroof likewise makes a unique visual impression, as it lends lightness and exclusivity to the interior. Innovative: control via Touch Slider.

THERMOTRONIC

4-zone automatic climate control: allows an individually regulated climate to be set for the driver, front passenger and left and right sides in the rear.

¹Price and availability subject to vehicle specification

Owing to supply shortages, options for vehicles may be temporarily restricted, resulting in modified vehicle and/or package pricing. Regularly updated information on this issue is available from Mercedes-Benz dealers.



Premium Plus Package From¹ €17,521

In addition to/replacement of Premium Package components

Multicontour Front Seats with Active Cushion & Hot-stone Massage Effect

Tailor-made and designed to pamper: These seats combine a host of adjustment options with exclusive feel-good extras. Ergonomic details enable you to adopt a perfect seating position. Innovative side bolsters ensure strong lateral support. The pleasant massage effects, some with gratifying warmth, make every journey a treat.

- Fully power-adjustable driver and front passenger seat, adjustable via the switches in the door control panel:
- Active cushion with inflatable air chambers in the lower backrest and side bolsters (not in conjunction with sport seats)
- Dynamically inflatable air chambers generate an ENERGIZING massage function of different intensities
- Hot-stone massage effect in the lumbar region
- Seat Heating Plus for the driver and front passenger, for particularly fast warming of the seat



¹Price and availability subject to vehicle specification
Owing to supply shortages, options for vehicles may be temporarily restricted, resulting in modified vehicle and/or package pricing. Regularly updated information on this issue is available from Mercedes-Benz dealers.

Night Package

From¹ €1,273

With the Night package, your sporty exterior looks even more expressive. In this case numerous features are in black or black chrome. Depending on the paint finish, this creates contrasts or flowing transitions. Regardless of how, it's always a clear plus for your individuality.

- Exterior mirror housings in high-gloss black, painted in the vehicle colour if non-metallic black paint finish is specified
- Mirror base in black
- Beltline and windowline trim strips in black
- Dark-tinted thermal insulation glass (840) from the B-pillar to the rear, optional omission of dark-tinted thermal insulation glass (U50)
- Trim strip in the doors in black chrome

for Electric Art Exterior

- Upper and lower trim element of the front apron in black chrome
- Trim element of the rear apron in black chrome

for AMG Line Exterior

- A-wing front splitter trim and horizontal fins in the outer air inlets in black chrome
- Trim element with two louvres on the rear apron in black chrome



¹Price and availability subject to vehicle specification

Owing to supply shortages, options for vehicles may be temporarily restricted, resulting in modified vehicle and/or package pricing. Regularly updated information on this issue is available from Mercedes-Benz dealers.

Hyperscreen package (from €12,212)

Enhance your interior with an impressive design feature. As if cast from a single mould, 3 displays seamlessly blend together beneath a glass panel to create one large MBUX hyperscreen. Brilliant OLED technology enhances your display comfort, while the haptic feedback helps to simplify input on the touchscreen.

Hyperscreen package

Consisting of:

17.7-inch central display and a 12.3-inch passenger display

Augmented navigation head-up display - this head-up display projects visual information into your field of vision without distracting you. For example, large direction arrows float above a junction where you need to make a turn. You immediately know what needs to be done

Fingerprint scanner

OLED high-end screens are right next to each other, with minimal space in between to give the impression that this is one large screen



Technical data

● Standard

Model	EQS 450+
Motor	
Battery type	lithium-ion high-voltage
Electric motor type	asynchronous
Battery capacity	kWh 107.8
Power ¹	hp (kW) 333 (245)
Torque ¹	Nm at rpm 568/4,060
On-board charger	11 kW AC; 200 kW DC
Emissions standard	EU6
Transmission	
Single-speed automatic	●
Performance	
Acceleration 0–100 kph	sec 6.2
Top speed	kph 210
Charging time	
Public Rapid charger (200 kW DC) 10–80% ³	31 mins
Wallbox (11 kW AC) 10–100% ⁴	10 hrs
Home wallbox (7.4 kW AC) 10–100% ³	15 hrs 30 mins
Range power consumption combined ^{4,5}	Wh/km 193–170
Electric range – WLTP ⁴	km 738–745

Model	EQS 450+
Weights and capacities	
Kerb weight ⁵	kg 2,480
Perm. Gross Vehicle Weight	kg 2,945
Boot capacity – seats up/down	l 610/1,770
Towing capacity – unbraked/braked	kg 750/750
Turning circle	m 11.9

¹Figures according to Regulation (EC) No. 595/2009 in the currently applicable version ²Specified voltage and current values refer to network infrastructure and can be limited by the vehicle. Times are from 10–100% charge using a wallbox (three-phase) or standard socket (single-phase) ³If you are planning to charge your Mercedes-Benz plug-in electric vehicle using a 3-pin domestic plug socket you must get a qualified electrician to inspect and sign off the socket to confirm it is safe and suitable to charge your vehicle. Do not use an electric vehicle 3-pin charge cable with an extension cord) ⁴Figures shown are for comparability purposes; only compare with other cars tested to the same technical procedures. Figures may not reflect real life driving results, which will depend upon a number of factors including the starting charge of the battery, factory-fitted options, accessories fitted (post registration), variations in weather, driving styles and vehicle load. ⁵Specified voltage and current values refer to network infrastructure and can be limited by the vehicle. Times are from 10–80% charge using public rapid charging at 100 kW ⁶Mass of the vehicle in running order with at least 90% full fuel tank, plus the mass of the driver (estimated by law at 75 kg), fuel and fluids, equipped with the standard equipment as specified by the manufacturer as well as, where applicable, the mass of the body cab, trailer coupling and spare wheel(s) as well as tools. Optional extras, additional equipment and accessories can influence the weight, residual payload, rolling resistance, aerodynamics, etc., and therefore also affect the consumption/CO₂ values

EQS

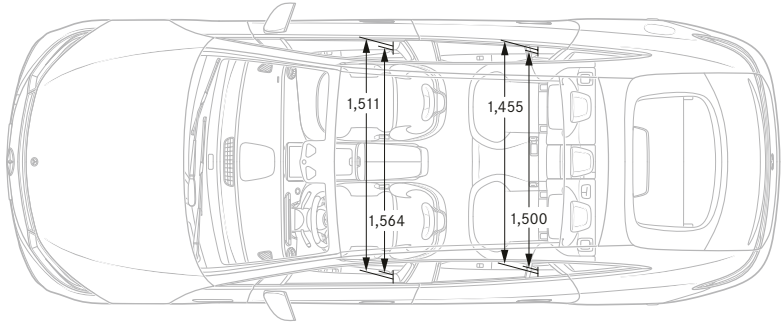
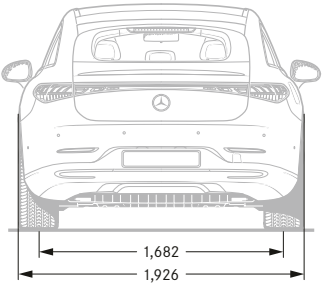
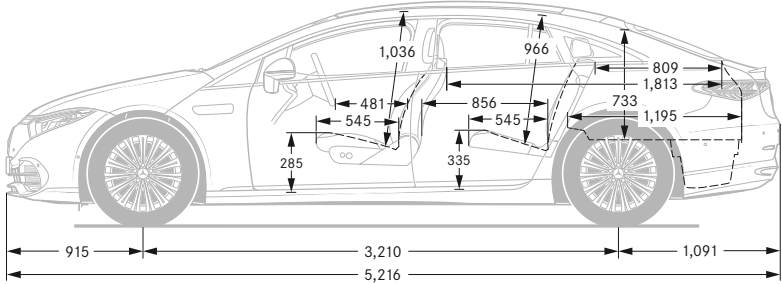
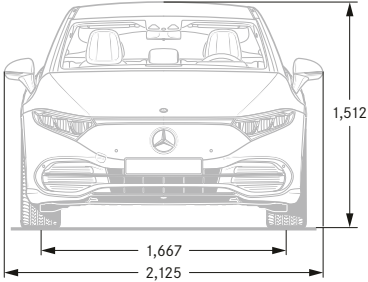

All measurements in millimetres. The dimensions shown are mean values and apply to standard-specification, unladen vehicles. Dimensions may vary slightly depending on the engine. Please consult your Retailer for further information



Mercedes me

Welcome to your Mercedes-Benz world.

Imagine if ...you could connect with your Mercedes-Benz? With Mercedes me connect, you can! Mercedes me connect offers you new connectivity services that make driving more comfortable and incorporates your car into your personal lifestyle.

Standard Services

- Maintenance Management
- Telediagnosics
- Breakdown Management
- Accident Recovery
- Mercedes-Benz Emergency Call System

Remote Online Services¹

- Remote Retrieval of Vehicle Status (fuel level, tyre pressure etc.)
- Parked Vehicle Locator
- Vehicle Tracker
- Geofencing
- Door lock / unlock function

¹ Can be used with Remote Online special feature.





Getting connected is easy. Just set up your Mercedes me account and get in touch with your Mercedes-Benz dealer to connect your vehicle to your profile to access your Mercedes me connect services.

Contact your dealer to get connected, or go to www.mercedes.me for more details.

Follow us on the following social media channels:

 facebook.com/MercedesBenzCarsIreland

 instagram.com/mercedesbenz_cars_ireland

 linkedin.com/company/motor-distributors-ltd

 twitter.com/MercedesBenzIre

 youtube.com/mercedes-benzireland

Motor Distributors Ltd.
Naas Road
Dublin 12
Ireland
www.mercedes-benz.ie

Information correct at time of going to print. Prices and specifications are subject to change without prior notice. Prices quoted do not include dealer and delivery related charges. Images are for illustrative purposes only, actual product may vary. For more specific information in relation to the range of models, features, optional extras, colours and services available please speak to your local authorised Mercedes-Benz dealer.